

## HIGHLIGHTS OF PRESCRIBING INFORMATION

These highlights do not include all the information needed to use ERELZI™ safely and effectively. See full prescribing information for ERELZI.

### ERELZI (etanercept-szszs) injection, for subcutaneous use

Initial U.S. Approval: 2016

ERELZI (etanercept-szszs) is biosimilar to ENBREL® (etanercept).\*

#### WARNINGS: SERIOUS INFECTIONS AND MALIGNANCIES See full prescribing information for complete boxed warning.

##### SERIOUS INFECTIONS

- Increased risk of serious infections leading to hospitalization or death, including tuberculosis (TB), bacterial sepsis, invasive fungal infections (such as histoplasmosis), and infections due to other opportunistic pathogens (5.1)
- ERELZI should be discontinued if a patient develops a serious infection or sepsis during treatment (5.1)
- Perform test for latent TB; if positive, start treatment for TB prior to starting ERELZI (5.1)
- Monitor all patients for active TB during treatment, even if initial latent TB test is negative (5.1)

##### MALIGNANCIES

- Lymphoma and other malignancies, some fatal, have been reported in children and adolescent patients treated with TNF blockers, including etanercept products (5.3)

#### INDICATIONS AND USAGE

ERELZI is a tumor necrosis factor (TNF) blocker indicated for treatment of:

- Rheumatoid Arthritis (RA) (1.1)
- Polyarticular Juvenile Idiopathic Arthritis (JIA) in patients aged 2 years or older (1.2)
- Ankylosing Spondylitis (AS) (1.3)

#### DOSAGE AND ADMINISTRATION

ERELZI is administered by subcutaneous injection.

- Adult RA: 50 mg once weekly with or without methotrexate (MTX) (2.1)
- AS: 50 mg once weekly (2.1)
- JIA (patients who weigh > 63 kg): 0.8 mg/kg weekly, with a maximum of 50 mg per week (2.2)

#### DOSAGE FORMS AND STRENGTHS

- Injection: 25 mg/0.5 mL and 50 mg/mL solution in a single-dose prefilled syringe with BD UltraSafe Passive® Needle Guard (3)
- Injection: 50 mg/mL solution in single-dose prefilled Sensoready® Pen (3)

#### CONTRAINDICATIONS

Sepsis (4)

#### WARNINGS AND PRECAUTIONS

- Do not start ERELZI during an active infection. If an infection develops, monitor carefully and stop ERELZI if infection becomes serious (5.1)
- Consider empiric anti-fungal therapy for patients at risk for invasive fungal infections who develop a severe systemic illness on ERELZI (those who reside or travel to regions where mycoses are endemic) (5.1)
- Demyelinating disease, exacerbation or new onset, may occur (5.2)
- Cases of lymphoma have been observed in patients receiving TNF-blocking agents (5.3)
- Congestive heart failure, worsening or new onset, may occur (5.4)
- Advise patients to seek immediate medical attention if symptoms of pancytopenia or aplastic anemia develop, and consider stopping ERELZI (5.5)
- Monitor patients previously infected with hepatitis B virus for reactivation during and several months after therapy. If reactivation occurs, consider stopping ERELZI and beginning anti-viral therapy (5.6)
- Anaphylaxis or serious allergic reactions may occur (5.7)
- Stop ERELZI if lupus-like syndrome or autoimmune hepatitis develops (5.9)

#### ADVERSE REACTIONS

Most common adverse reactions (incidence > 5%): infections and injection site reactions (6.1)

To report SUSPECTED ADVERSE REACTIONS, contact Sandoz Inc. at 1-800-525-8747 or FDA at 1-800-FDA-1088 or www.fda.gov/medwatch

#### DRUG INTERACTIONS

- Live vaccines – should not be given with ERELZI (5.8, 7.1)
- Anakinra – increased risk of serious infection (5.12, 7.2)
- Abatacept – increased risk of serious adverse events, including infections (5.12, 7.2)
- Cyclophosphamide – use with ERELZI is not recommended (7.3)

See 17 for PATIENT COUNSELING INFORMATION and Medication Guide.

\* Biosimilar means that the biological product is approved based on data demonstrating that it is highly similar to an FDA-approved biological product, known as a reference product, and that there are no clinically meaningful differences between the biosimilar product and the reference product. Biosimilarity of ERELZI has been demonstrated for the condition(s) of use (e.g. indication(s), dosing regimen(s)), strength(s), dosage form(s), and route(s) of administration described in its Full Prescribing Information.

Revised: 01/2018

## FULL PRESCRIBING INFORMATION: CONTENTS\*

### WARNINGS: SERIOUS INFECTIONS AND MALIGNANCIES

#### 1 INDICATIONS AND USAGE

- 1.1 Rheumatoid Arthritis
- 1.2 Polyarticular Juvenile Idiopathic Arthritis
- 1.3 Ankylosing Spondylitis

#### 2 DOSAGE AND ADMINISTRATION

- 2.1 Adult Rheumatoid Arthritis and Ankylosing Spondylitis Patients
- 2.2 JIA Patients
- 2.3 Preparation of ERELZI
- 2.4 Monitoring to Assess Safety

#### 3 DOSAGE FORMS AND STRENGTHS

#### 4 CONTRAINDICATIONS

#### 5 WARNINGS AND PRECAUTIONS

- 5.1 Serious Infections
- 5.2 Neurologic Reactions
- 5.3 Malignancies
- 5.4 Patients With Heart Failure
- 5.5 Hematologic Reactions
- 5.6 Hepatitis B Reactivation
- 5.7 Allergic Reactions
- 5.8 Immunizations
- 5.9 Autoimmunity

5.10 Immunosuppression

5.11 Use in Wegener's Granulomatosis Patients

5.12 Use with Anakinra or Abatacept

5.13 Use in Patients with Moderate to Severe Alcoholic Hepatitis

#### 6 ADVERSE REACTIONS

- 6.1 Clinical Trials Experience
- 6.2 Immunogenicity
- 6.3 Postmarketing Experience

#### 7 DRUG INTERACTIONS

- 7.1 Vaccines
- 7.2 Immune-Modulating Biologic Products
- 7.3 Cyclophosphamide
- 7.4 Sulfasalazine

#### 8 USE IN SPECIFIC POPULATIONS

- 8.1 Pregnancy
- 8.2 Lactation
- 8.4 Pediatric Use
- 8.5 Geriatric Use
- 8.6 Use in Diabetics

#### 10 OVERDOSAGE

#### 11 DESCRIPTION

#### 12 CLINICAL PHARMACOLOGY

- 12.1 Mechanism of Action
- 12.2 Pharmacodynamics

- 12.3 Pharmacokinetics
- 13 NONCLINICAL TOXICOLOGY**
- 13.1 Carcinogenesis, Mutagenesis, Impairment of Fertility
- 14 CLINICAL STUDIES**
- 14.1 Adult Rheumatoid Arthritis

- 14.2 Polyarticular Juvenile Idiopathic Arthritis (JIA)
- 14.3 Ankylosing Spondylitis
- 15 REFERENCES**
- 16 HOW SUPPLIED/STORAGE AND HANDLING**
- 17 PATIENT COUNSELING INFORMATION**

\*Sections or subsections omitted from the full prescribing information are not listed.

---

## FULL PRESCRIBING INFORMATION

### WARNINGS: SERIOUS INFECTIONS AND MALIGNANCIES

#### **SERIOUS INFECTIONS**

Patients treated with etanercept products are at increased risk for developing serious infections that may lead to hospitalization or death [see *Warnings and Precautions* (5.1) and *Adverse Reactions* (6)]. Most patients treated with etanercept products who developed these infections were taking concomitant immunosuppressants such as methotrexate or corticosteroids.

ERELZI should be discontinued if a patient develops a serious infection or sepsis.

Reported infections include:

- Active tuberculosis, including reactivation of latent tuberculosis. Patients with tuberculosis have frequently presented with disseminated or extrapulmonary disease. Patients should be tested for latent tuberculosis before ERELZI use and during therapy. Treatment for latent infection should be initiated prior to ERELZI use.
- Invasive fungal infections, including histoplasmosis, coccidioidomycosis, candidiasis, aspergillosis, blastomycosis, and pneumocystosis. Patients with histoplasmosis or other invasive fungal infections may present with disseminated, rather than localized, disease. Antigen and antibody testing for histoplasmosis may be negative in some patients with active infection. Empiric anti-fungal therapy should be considered in patients at risk for invasive fungal infections who develop severe systemic illness.
- Bacterial, viral, and other infections due to opportunistic pathogens, including Legionella and Listeria.

The risks and benefits of treatment with ERELZI should be carefully considered prior to initiating therapy in patients with chronic or recurrent infection.

Patients should be closely monitored for the development of signs and symptoms of infection during and after treatment with ERELZI, including the possible development of tuberculosis in patients who tested negative for latent tuberculosis infection prior to initiating therapy.

#### **MALIGNANCIES**

Lymphoma and other malignancies, some fatal, have been reported in children and adolescent patients treated with TNF blockers, including etanercept products.

## 1 INDICATIONS AND USAGE

### 1.1 Rheumatoid Arthritis

ERELZI is indicated for reducing signs and symptoms, inducing major clinical response, inhibiting the progression of structural damage, and improving physical function in patients with moderately to severely active rheumatoid arthritis (RA). ERELZI can be initiated in combination with methotrexate (MTX) or used alone.

### 1.2 Polyarticular Juvenile Idiopathic Arthritis

ERELZI is indicated for reducing signs and symptoms of moderately to severely active polyarticular juvenile idiopathic arthritis (JIA) in patients ages 2 and older.

### 1.3 Ankylosing Spondylitis

ERELZI is indicated for reducing signs and symptoms in patients with active ankylosing spondylitis (AS).

## 2 DOSAGE AND ADMINISTRATION

ERELZI is administered by subcutaneous injection.

**Table 1. Dosing and Administration for Adult Patients**

Patient Population	Recommended Dosage Strength and Frequency
Adult RA and AS	50 mg weekly

See the ERELZI (etanercept-szszs) “Instructions for Use” insert for detailed information on injection site selection and dose administration. [see *Dosage and Administration (2.2)* and *Patient Counseling Information (17)*]

### 2.1 Adult Rheumatoid Arthritis and Ankylosing Spondylitis Patients

Methotrexate, glucocorticoids, salicylates, nonsteroidal anti-inflammatory drugs (NSAIDs), or analgesics may be continued during treatment with ERELZI.

Based on a study of 50 mg etanercept twice weekly in patients with RA that suggested higher incidence of adverse reactions but similar American College of Rheumatology (ACR) response rates, doses higher than 50 mg per week are not recommended.

### 2.2 JIA Patients

**Table 2. Dosing and Administration for Juvenile Idiopathic Arthritis**

Pediatric Patients Weight	Recommended Dose
63 kg (138 pounds) or more	50 mg weekly

**Note: There is no dosage form for ERELZI that allows weight based dosing for pediatric patients below 63 kg.**

Doses of ERELZI higher than those described in Table 2 have not been studied in pediatric patients.

In JIA patients, glucocorticoids, NSAIDs, or analgesics may be continued during treatment with ERELZI.

### **2.3 Preparation of ERELZI**

ERELZI is intended for use under the guidance and supervision of a physician. Patients may self-inject when deemed appropriate and if they receive medical follow-up, as necessary. Patients should not self-administer until they receive proper training in how to prepare and administer the correct dose. Administer injections subcutaneously in the thigh, abdomen, or outer area of the upper arm.

The ERELZI (etanercept-szzs) “Instructions for Use” insert for each presentation contains more detailed instructions on injection site selection and the preparation of ERELZI.

#### Preparation of ERELZI Single-dose Prefilled Syringe or Single-dose Prefilled Sensoready Pen

Leave ERELZI at room temperature for about 15 to 30 minutes before injecting. DO NOT remove the needle cover while allowing the prefilled syringe to reach room temperature.

Inspect visually for particulate matter and discoloration prior to administration. There may be small white particles of protein in the solution. This is not unusual for proteinaceous solutions. The solution should not be used if discolored or cloudy, or if foreign particulate matter is present.

### **2.4 Monitoring to Assess Safety**

Prior to initiating ERELZI and periodically during therapy, patients should be evaluated for active tuberculosis and tested for latent infection [*see Warnings and Precautions (5.1)*].

## **3 DOSAGE FORMS AND STRENGTHS**

ERELZI is a clear and colorless to slightly yellow solution available as:

- Injection: 25 mg/0.5 mL and 50 mg/mL solution in a single-dose prefilled syringe with BD UltraSafe Passive™ Needle Guard
- Injection: 50 mg/mL solution in a single-dose prefilled Sensoready® Pen

## **4 CONTRAINDICATIONS**

ERELZI should not be administered to patients with sepsis.

## **5 WARNINGS AND PRECAUTIONS**

### **5.1 Serious Infections**

Patients treated with ERELZI are at increased risk for developing serious infections involving various organ systems and sites that may lead to hospitalization or death.

Opportunistic infections due to bacterial, mycobacterial, invasive fungal, viral, parasitic, or other opportunistic pathogens including aspergillosis, blastomycosis, candidiasis, coccidioidomycosis, histoplasmosis, legionellosis, listeriosis, pneumocystosis, and tuberculosis have been reported with TNF blockers. Patients have frequently presented with disseminated rather than localized disease.

Treatment with ERELZI should not be initiated in patients with an active infection, including clinically important localized infections. Patients greater than 65 years of age, patients with comorbid conditions, and/or patients taking concomitant immunosuppressants (such as

corticosteroids or methotrexate), may be at greater risk of infection. The risks and benefits of treatment should be considered prior to initiating therapy in patients:

- With chronic or recurrent infection;
- Who have been exposed to tuberculosis;
- With a history of an opportunistic infection;
- Who have resided or traveled in areas of endemic tuberculosis or endemic mycoses, such as histoplasmosis, coccidioidomycosis, or blastomycosis; or
- With underlying conditions that may predispose them to infection, such as advanced or poorly controlled diabetes [*see Adverse Reactions (6.1)*].

Patients should be closely monitored for the development of signs and symptoms of infection during and after treatment with ERELZI.

ERELZI should be discontinued if a patient develops a serious infection or sepsis. A patient who develops a new infection during treatment with ERELZI should be closely monitored, undergo a prompt and complete diagnostic workup appropriate for an immunocompromised patient, and appropriate antimicrobial therapy should be initiated.

#### Tuberculosis

Cases of reactivation of tuberculosis or new tuberculosis infections have been observed in patients receiving etanercept products, including patients who have previously received treatment for latent or active tuberculosis. Data from clinical trials and preclinical studies suggest that the risk of reactivation of latent tuberculosis infection is lower with etanercept products than with TNF-blocking monoclonal antibodies. Nonetheless, postmarketing cases of tuberculosis reactivation have been reported for TNF blockers, including etanercept products. Tuberculosis has developed in patients who tested negative for latent tuberculosis prior to initiation of therapy. Patients should be evaluated for tuberculosis risk factors and tested for latent infection prior to initiating ERELZI and periodically during therapy. Tests for latent tuberculosis infection may be falsely negative while on therapy with ERELZI.

Treatment of latent tuberculosis infection prior to therapy with TNF-blocking agents has been shown to reduce the risk of tuberculosis reactivation during therapy. Induration of 5 mm or greater with tuberculin skin testing should be considered a positive test result when assessing if treatment for latent tuberculosis is needed prior to initiating ERELZI, even for patients previously vaccinated with Bacille Calmette-Guerin (BCG).

Anti-tuberculosis therapy should also be considered prior to initiation of ERELZI in patients with a past history of latent or active tuberculosis in whom an adequate course of treatment cannot be confirmed, and for patients with a negative test for latent tuberculosis but having risk factors for tuberculosis infection. Consultation with a physician with expertise in the treatment of tuberculosis is recommended to aid in the decision whether initiating anti-tuberculosis therapy is appropriate for an individual patient.

Tuberculosis should be strongly considered in patients who develop a new infection during ERELZI treatment, especially in patients who have previously or recently traveled to countries

with a high prevalence of tuberculosis, or who have had close contact with a person with active tuberculosis.

### Invasive Fungal Infections

Cases of serious and sometimes fatal fungal infections, including histoplasmosis, have been reported with TNF blockers, including etanercept products. For patients who reside or travel in regions where mycoses are endemic, invasive fungal infection should be suspected if they develop a serious systemic illness. Appropriate empiric anti-fungal therapy should be considered while a diagnostic workup is being performed. Antigen and antibody testing for histoplasmosis may be negative in some patients with active infection. When feasible, the decision to administer empiric anti-fungal therapy in these patients should be made in consultation with a physician with expertise in the diagnosis and treatment of invasive fungal infections and should take into account both the risk for severe fungal infection and the risks of anti-fungal therapy. In 38 of etanercept's clinical trials and 4 cohort studies in all approved indications representing 27,169 patient-years of exposure (17,696 patients) from the United States and Canada, no histoplasmosis infections were reported among patients treated with etanercept products.

### **5.2 Neurologic Reactions**

Treatment with TNF-blocking agents, including etanercept products, has been associated with rare (< 0.1%) cases of new onset or exacerbation of central nervous system demyelinating disorders, some presenting with mental status changes and some associated with permanent disability, and with peripheral nervous system demyelinating disorders. Cases of transverse myelitis, optic neuritis, multiple sclerosis, Guillain-Barre syndromes, other peripheral demyelinating neuropathies, and new onset or exacerbation of seizure disorders have been reported in postmarketing experience with etanercept products therapy. Prescribers should exercise caution in considering the use of ERELZI in patients with preexisting or recent-onset central or peripheral nervous system demyelinating disorders [*see Adverse Reactions (6.3)*].

### **5.3 Malignancies**

#### Lymphomas

In the controlled portions of clinical trials of TNF-blocking agents, more cases of lymphoma have been observed among patients receiving a TNF blocker compared to control patients. During the controlled portions of etanercept's trials in adult patients with RA, AS, and another indication, 2 lymphomas were observed among 3306 etanercept-treated patients versus 0 among 1521 control patients (duration of controlled treatment ranged from 3 to 36 months).

Among 6543 adult rheumatology patients with RA, AS, and another indication treated with etanercept in controlled and uncontrolled portions of clinical trials, representing approximately 12,845 patient-years of therapy, the observed rate of lymphoma was 0.10 cases per 100 patient-years. This was 3-fold higher than the rate of lymphoma expected in the general U.S. population based on the Surveillance, Epidemiology, and End Results (SEER) Database. An increased rate of lymphoma up to several-fold has been reported in the RA patient population, and may be further increased in patients with more severe disease activity.

### Leukemia

Cases of acute and chronic leukemia have been reported in association with postmarketing TNF-blocker use in rheumatoid arthritis and other indications. Even in the absence of TNF-blocker therapy, patients with rheumatoid arthritis may be at higher risk (approximately 2-fold) than the general population for the development of leukemia.

During the controlled portions of etanercept's trials, 2 cases of leukemia were observed among 5445 (0.06 cases per 100 patient-years) etanercept-treated patients versus 0 among 2890 (0%) control patients (duration of controlled treatment ranged from 3 to 48 months).

Among 15,401 patients treated with etanercept in controlled and open portions of clinical trials representing approximately 23,325 patient-years of therapy, the observed rate of leukemia was 0.03 cases per 100 patient-years.

### Other Malignancies

Information is available from 10,953 adult patients with 17,123 patient-years and 696 pediatric patients with 1282 patient-years of experience across 45 etanercept clinical studies.

For malignancies other than lymphoma and non-melanoma skin cancer, there was no difference in exposure-adjusted rates between etanercept and control arms in the controlled portions of clinical studies for all indications. Analysis of the malignancy rate in combined controlled and uncontrolled portions of studies has demonstrated that types and rates are similar to what is expected in the general U.S. population based on the SEER database and suggests no increase in rates over time. Whether treatment with etanercept products might influence the development and course of malignancies in adults is unknown.

### Melanoma and Non-Melanoma Skin Cancer (NMSC)

Melanoma and non-melanoma skin cancer has been reported in patients treated with TNF antagonists including etanercept products.

Among 15,401 patients treated with etanercept in controlled and open portions of clinical trials representing approximately 23,325 patient-years of therapy, the observed rate of melanoma was 0.043 cases per 100 patient-years.

Among 3306 adult rheumatology (RA, AS, and another indication), patients treated with etanercept in controlled clinical trials representing approximately 2669 patient-years of therapy, the observed rate of NMSC was 0.41 cases per 100 patient-years vs 0.37 cases per 100 patient-years among 1521 control-treated patients representing 1077 patient-years.

Postmarketing cases of Merkel cell carcinoma have been reported very infrequently in patients treated with etanercept products.

Periodic skin examinations should be considered for all patients at increased risk for skin cancer.

### Pediatric Patients

Malignancies, some fatal, have been reported among children, adolescents, and young adults who received treatment with TNF-blocking agents (initiation of therapy at  $\leq 18$  years of age), including etanercept products. Approximately half the cases were lymphomas, including



Hodgkin's and non-Hodgkin's lymphoma. The other cases represented a variety of different malignancies and included rare malignancies usually associated with immunosuppression and malignancies that are not usually observed in children and adolescents. The malignancies occurred after a median of 30 months of therapy (range 1 to 84 months). Most of the patients were receiving concomitant immunosuppressants. These cases were reported postmarketing and are derived from a variety of sources, including registries and spontaneous postmarketing reports.

In clinical trials of 1140 pediatric patients representing 1927.2 patient-years of therapy, no malignancies, including lymphoma or NMSC, have been reported.

#### Postmarketing Use

In global postmarketing adult and pediatric use, lymphoma and other malignancies have been reported.

#### **5.4 Patients With Heart Failure**

Two clinical trials evaluating the use of etanercept in the treatment of heart failure were terminated early due to lack of efficacy. One of these studies suggested higher mortality in etanercept-treated patients compared to placebo [*see Adverse Reactions (6.3)*]. There have been postmarketing reports of worsening of congestive heart failure (CHF), with and without identifiable precipitating factors, in patients taking etanercept products. There have also been rare (< 0.1%) reports of new onset CHF, including CHF in patients without known preexisting cardiovascular disease. Some of these patients have been under 50 years of age. Physicians should exercise caution when using ERELZI in patients who also have heart failure, and monitor patients carefully.

#### **5.5 Hematologic Reactions**

Rare (< 0.1%) reports of pancytopenia, including very rare (< 0.01%) reports of aplastic anemia, some with a fatal outcome, have been reported in patients treated with etanercept. The causal relationship to therapy with etanercept products remains unclear. Although no high-risk group has been identified, caution should be exercised in patients being treated with ERELZI who have a previous history of significant hematologic abnormalities. All patients should be advised to seek immediate medical attention if they develop signs and symptoms suggestive of blood dyscrasias or infection (e.g., persistent fever, bruising, bleeding, pallor) while on ERELZI. Discontinuation of ERELZI therapy should be considered in patients with confirmed significant hematologic abnormalities.

Two percent of patients treated concurrently with etanercept and anakinra developed neutropenia (ANC <  $1 \times 10^9$  /L). While neutropenic, one patient developed cellulitis that resolved with antibiotic therapy.

#### **5.6 Hepatitis B Reactivation**

Reactivation of hepatitis B in patients who were previously infected with the hepatitis B virus (HBV) and had received concomitant TNF-blocking agents, including very rare cases (< 0.01%) with etanercept, has been reported. In some instances, hepatitis B reactivation occurring in conjunction with TNF-blocker therapy has been fatal. The majority of these reports have

occurred in patients concomitantly receiving other medications that suppress the immune system, which may also contribute to hepatitis B reactivation. Patients at risk for HBV infection should be evaluated for prior evidence of HBV infection before initiating TNF-blocker therapy. Prescribers should exercise caution in prescribing TNF blockers in patients previously infected with HBV. Adequate data are not available on the safety or efficacy of treating patients who are carriers of HBV with anti-viral therapy in conjunction with TNF blocker therapy to prevent HBV reactivation. Patients previously infected with HBV and requiring treatment with ERELZI should be closely monitored for clinical and laboratory signs of active HBV infection throughout therapy and for several months following termination of therapy. In patients who develop HBV reactivation, consideration should be given to stopping ERELZI and initiating anti-viral therapy with appropriate supportive treatment. The safety of resuming therapy with etanercept products after HBV reactivation is controlled is not known. Therefore, prescribers should weigh the risks and benefits when considering resumption of therapy in this situation.

### **5.7 Allergic Reactions**

Allergic reactions associated with administration of etanercept during clinical trials have been reported in < 2% of patients. If an anaphylactic reaction or other serious allergic reaction occurs, administration of ERELZI should be discontinued immediately and appropriate therapy initiated. Caution: The following components contain dry natural rubber (a derivative of latex), which may cause allergic reactions in individuals sensitive to latex: the needle cap of the prefilled syringe and the internal needle cover within the cap of the Sensoready Pen.

### **5.8 Immunizations**

Live vaccines should not be given concurrently with ERELZI. It is recommended that pediatric patients, if possible, be brought up-to-date with all immunizations in agreement with current immunization guidelines prior to initiating ERELZI therapy [see *Drug Interactions (7.1)* and *Use in Specific Populations (8.4)*].

### **5.9 Autoimmunity**

Treatment with ERELZI may result in the formation of autoantibodies [see *Adverse Reactions (6.1)*] and, rarely (< 0.1%), in the development of a lupus-like syndrome or autoimmune hepatitis [see *Adverse Reactions (6.3)*], which may resolve following withdrawal of ERELZI. If a patient develops symptoms and findings suggestive of a lupus-like syndrome or autoimmune hepatitis following treatment with ERELZI, treatment should be discontinued and the patient should be carefully evaluated.

### **5.10 Immunosuppression**

TNF mediates inflammation and modulates cellular immune responses. TNF-blocking agents, including ERELZI, affect host defenses against infections. The effect of TNF inhibition on the development and course of malignancies is not fully understood. In a study of 49 patients with RA treated with etanercept, there was no evidence of depression of delayed-type hypersensitivity, depression of immunoglobulin levels, or change in enumeration of effector cell populations [see *Warnings and Precautions (5.1, 5.3)* and *Adverse Reactions (6.1)*].

### **5.11 Use in Wegener's Granulomatosis Patients**

The use of ERELZI in patients with Wegener's granulomatosis receiving immunosuppressive agents is not recommended. In a study of patients with Wegener's granulomatosis, the addition of etanercept to standard therapy (including cyclophosphamide) was associated with a higher incidence of non-cutaneous solid malignancies and was not associated with improved clinical outcomes when compared with standard therapy alone [see *Drug Interactions* ([7.3](#))].

### **5.12 Use with Anakinra or Abatacept**

Use of ERELZI with anakinra or abatacept is not recommended [see *Drug Interactions* ([7.2](#))].

### **5.13 Use in Patients with Moderate to Severe Alcoholic Hepatitis**

In a study of 48 hospitalized patients treated with etanercept or placebo for moderate to severe alcoholic hepatitis, the mortality rate in patients treated with etanercept was similar to patients treated with placebo at 1 month but significantly higher after 6 months. Physicians should use caution when using ERELZI in patients with moderate to severe alcoholic hepatitis.

## **6 ADVERSE REACTIONS**

The following serious adverse reactions are discussed in greater detail in other sections of the labeling:

- Serious Infections [see *Boxed Warning and Warnings and Precautions* ([5.1](#))]
- Neurologic Reactions [see *Warnings and Precautions* ([5.2](#))]
- Malignancies [see *Boxed Warning and Warnings and Precautions* ([5.3](#))]
- Patients with Heart Failure [see *Warnings and Precautions* ([5.4](#))]
- Hematologic Reactions [see *Warnings and Precautions* ([5.5](#))]
- Hepatitis B Reactivation [see *Warnings and Precautions* ([5.6](#))]
- Allergic Reactions [see *Warnings and Precautions* ([5.7](#))]
- Autoimmunity [see *Warnings and Precautions* ([5.9](#))]
- Immunosuppression [see *Warnings and Precautions* ([5.10](#))]

### **6.1 Clinical Trials Experience**

Across clinical studies and postmarketing experience, the most serious adverse reactions with etanercept were infections, neurologic events, CHF, and hematologic events [see *Warnings and Precautions* ([5](#))]. The most common adverse reactions with etanercept were infections and injection site reactions.

Because clinical trials are conducted under widely varying conditions, adverse reactions rates observed in the clinical trials of a drug cannot be directly compared to rates in the clinical trials of another drug and may not predict the rates observed in clinical practice.

### Adverse Reactions in Adult Patients with Rheumatoid Arthritis, Ankylosing Spondylitis, and two other indications

The data described below reflect exposure to etanercept in 2219 adult patients with RA followed for up to 80 months, in 182 patients with another indication for up to 24 months, in 138 patients with AS for up to 6 months, and in 1204 adult patients with another indication for up to 18 months).

In controlled trials, the proportion of etanercept-treated patients who discontinued treatment due to adverse events was approximately 4% in the indications studied.

### Adverse Reactions in Pediatric Patients

In general, the adverse reactions in pediatric patients were similar in frequency and type as those seen in adult patients [see *Warnings and Precautions* (5), *Use in Specific Populations* (8.4) and *Clinical Studies* (14.2)].

In open-label clinical studies of children with JIA, adverse reactions reported in those ages 2 to 4 years were similar to adverse reactions reported in older children.

### Infections

Infections, including viral, bacterial, and fungal infections, have been observed in adult and pediatric patients. Infections have been noted in all body systems and have been reported in patients receiving etanercept products alone or in combination with other immunosuppressive agents.

In controlled portions of trials, the types and severity of infection were similar between etanercept and the respective control group (placebo or MTX for patients with RA and another indication) in patients with RA, AS, and two other indications. Rates of infections in RA patients are provided in Table 3. Infections consisted primarily of upper respiratory tract infection, sinusitis and influenza.

In controlled portions of trials in RA, AS, and two other indications, the rates of serious infection were similar (0.8% in placebo, 3.6% in MTX, and 1.4% in etanercept/etanercept + MTX-treated groups). In clinical trials in rheumatologic indications, serious infections experienced by patients have included, but are not limited to, pneumonia, cellulitis, septic arthritis, bronchitis, gastroenteritis, pyelonephritis, sepsis, abscess and osteomyelitis. The rate of serious infections was not increased in open-label extension trials and was similar to that observed in etanercept- and placebo-treated patients from controlled trials.

In 66 global clinical trials of 17,505 patients (21,015 patient-years of therapy), tuberculosis was observed in approximately 0.02% of patients. In 17,696 patients (27,169 patient-years of therapy) from 38 clinical trials and 4 cohort studies in the U.S. and Canada, tuberculosis was observed in approximately 0.006% of patients. These studies include reports of pulmonary and extrapulmonary tuberculosis [see *Warnings and Precautions* (5.1)].

The types of infections reported in pediatric patients were generally mild and consistent with those commonly seen in the general pediatric population. Two JIA patients developed varicella infection and signs and symptoms of aseptic meningitis, which resolved without sequelae.

### Injection Site Reactions

In placebo-controlled trials in rheumatologic indications, approximately 37% of patients treated with etanercept developed injection site reactions. All injection site reactions were described as mild to moderate (erythema, itching, pain, swelling, bleeding, bruising) and generally did not necessitate drug discontinuation. Injection site reactions generally occurred in the first month and subsequently decreased in frequency. The mean duration of injection site reactions was 3 to 5 days. Seven percent of patients experienced redness at a previous injection site when subsequent injections were given.

### Other Adverse Reactions

Table 3 summarizes adverse reactions reported in adult RA patients. The types of adverse reactions seen in patients with AS are similar to the types of adverse reactions seen in patients with RA.

**Table 3. Percent of Adult RA Patients Experiencing Adverse Reactions in Controlled Clinical Trials**

Reaction	Placebo Controlled <sup>a</sup> (Studies I, II and a Phase 2 Study)		Active Controlled <sup>b</sup> (Study III)	
	Placebo (N= 152)	Etanercept <sup>c</sup> (N= 349)	MTX (N= 217)	Etanercept <sup>c</sup> (N= 415)
	Percent of Patients		Percent of Patients	
Infection <sup>d</sup> (total)	39	50	86	81
Upper Respiratory Infections <sup>e</sup>	30	38	70	65
Non-upper Respiratory Infections	15	21	59	54
Injection Site Reactions	11	37	18	43
Diarrhea	9	8	16	16
Rash	2	3	19	13
Pruritus	1	2	5	5
Pyrexia	-	3	4	2
Urticaria	1	-	4	2
Hypersensitivity	-	-	1	1

<sup>a</sup>Includes data from the 6-month study in which patients received concurrent MTX therapy in both arms.

<sup>b</sup>Study duration of 2 years.

<sup>c</sup>Any dose.

<sup>d</sup>Includes bacterial, viral and fungal infections.

<sup>e</sup>Most frequent Upper Respiratory Infections were upper respiratory tract infection, sinusitis, and influenza.

## 6.2 Immunogenicity

As with all therapeutic proteins, there is potential for immunogenicity. The detection of antibody formation is highly dependent on the sensitivity and specificity of the assay. Additionally, the observed incidence of antibody (including neutralizing antibody) positivity in an assay may be influenced by several factors including assay methodology, sample handling, timing of sample collection, concomitant medications, and underlying disease. For these reasons, comparison of the incidence of antibodies to etanercept in the studies described below with the incidence of antibodies in other studies or to other products may be misleading.

### Immunogenicity

Patients with RA, AS, and two other indications treated with etanercept were tested at multiple time points for antibodies to etanercept. Antibodies to the TNF receptor portion or other protein components of etanercept were detected at least once in sera of approximately 6% of adult patients with RA, AS or two other indications. These antibodies were all non-neutralizing. Results from JIA patients were similar to those seen in adult RA patients treated with etanercept.

The data reflect the percentage of patients whose test results were considered positive for antibodies to etanercept in an ELISA assay, and are highly dependent on the sensitivity and specificity of the assay.

### Autoantibodies

Patients with RA had serum samples tested for autoantibodies at multiple time points. In RA Studies I and II, the percentage of patients evaluated for antinuclear antibodies (ANA) who developed new positive ANA (titer  $\geq$  1:40) was higher in patients treated with etanercept (11%) than in placebo-treated patients (5%). The percentage of patients who developed new positive anti-double-stranded DNA antibodies was also higher by radioimmunoassay (15% of patients treated with etanercept compared to 4% of placebo-treated patients) and by *Crithidia luciliae* assay (3% of patients treated with etanercept compared to none of placebo-treated patients). The proportion of patients treated with etanercept who developed anticardiolipin antibodies was similarly increased compared to placebo-treated patients. In RA Study III, no pattern of increased autoantibody development was seen in etanercept's patients compared to MTX patients [see *Warnings and Precautions* (5.9)].

## 6.3 Postmarketing Experience

Adverse reactions have been reported during post approval use of etanercept in adults and pediatric patients. Because these reactions are reported voluntarily from a population of uncertain size, it is not always possible to reliably estimate their frequency or establish a causal relationship to etanercept exposure.

Adverse reactions are listed by body system below:

Blood and lymphatic system disorders:	pancytopenia, anemia, leukopenia, neutropenia, thrombocytopenia, lymphadenopathy, aplastic anemia [see <i>Warnings and Precautions</i> (5.5)]
Cardiac disorders:	congestive heart failure [see <i>Warnings and Precautions</i> (5.4)]
Gastrointestinal disorders:	inflammatory bowel disease (IBD)

General disorders:	angioedema, chest pain
Hepatobiliary disorders:	autoimmune hepatitis, elevated transaminases, hepatitis B reactivation
Immune disorders:	macrophage activation syndrome, systemic vasculitis, sarcoidosis
Musculoskeletal and connective tissue disorders:	lupus-like syndrome
Neoplasms benign, malignant, and unspecified:	melanoma and non-melanoma skin cancers, Merkel cell carcinoma [see Warnings and Precautions (5.3)]
Nervous system disorders:	convulsions, multiple sclerosis, demyelination, optic neuritis, transverse myelitis, paresthesias [see Warnings and Precautions (5.2)]
Ocular disorders:	uveitis, scleritis
Respiratory, thoracic and mediastinal disorders:	interstitial lung disease
Skin and subcutaneous tissue disorders:	cutaneous lupus erythematosus, cutaneous vasculitis (including leukocytoclastic vasculitis), erythema multiforme, Stevens-Johnson syndrome, toxic epidermal necrolysis, subcutaneous nodule, new or worsening psoriasis (all subtypes including pustular and palmoplantar)

Opportunistic infections, including atypical mycobacterial infection, herpes zoster, aspergillosis and *Pneumocystis jiroveci* pneumonia, and protozoal infections have also been reported in postmarketing use.

Rare (< 0.1%) cases of IBD have been reported in JIA patients receiving etanercept, which is not effective for the treatment of IBD.

## 7 DRUG INTERACTIONS

Specific drug interaction studies have not been conducted with etanercept products.

### 7.1 Vaccines

Patients receiving ERELZI may receive concurrent vaccinations, except for live vaccines. No data are available on the secondary transmission of infection by live vaccines in patients receiving etanercept products.

Patients with a significant exposure to varicella virus should temporarily discontinue ERELZI therapy and be considered for prophylactic treatment with varicella zoster immune globulin [see Warnings and Precautions (5.8, 5.10)].

### 7.2 Immune-Modulating Biologic Products

In a study in which patients with active RA were treated for up to 24 weeks concurrently with etanercept and anakinra therapy, a 7% rate of serious infections was observed, which was higher than that observed with etanercept alone (0%) [see Warnings and Precautions (5.12)] and did not result in higher ACR response rates compared to etanercept alone. The most common infections consisted of bacterial pneumonia (4 cases) and cellulitis (4 cases). One patient with pulmonary



fibrosis and pneumonia died due to respiratory failure. Two percent of patients treated concurrently with etanercept and anakinra developed neutropenia ( $ANC < 1 \times 10^9/L$ ).

In clinical studies, concurrent administration of abatacept and etanercept resulted in increased incidences of serious adverse events, including infections, and did not demonstrate increased clinical benefit [see *Warnings and Precautions* (5.12)].

### 7.3 Cyclophosphamide

The use of ERELZI in patients receiving concurrent cyclophosphamide therapy is not recommended [see *Warnings and Precautions* (5.11)].

### 7.4 Sulfasalazine

Patients in a clinical study who were on established therapy with sulfasalazine, to which etanercept was added, were noted to develop a mild decrease in mean neutrophil counts in comparison to groups treated with either etanercept or sulfasalazine alone. The clinical significance of this observation is unknown.

## 8 USE IN SPECIFIC POPULATIONS

### 8.1 Pregnancy

#### *Risk Summary*

Available studies with use of etanercept during pregnancy do not reliably support an association between etanercept and major birth defects. Clinical data are available from the Organization of Teratology Information Specialists (OTIS) Pregnancy Registry in women with rheumatic diseases or another indication and a Scandinavian study in pregnant women with chronic inflammatory disease. Both the OTIS Registry and the Scandinavian study showed the proportion of liveborn infants with major birth defects was higher for women exposed to etanercept compared to diseased etanercept unexposed women. However, the lack of pattern of major birth defects is reassuring and differences between exposure groups (e.g. disease severity) may have impacted the occurrence of birth defects [see *Data*]. In animal reproduction studies with pregnant rats and rabbits, no fetal harm or malformations were observed with subcutaneous administration of etanercept during the period of organogenesis at doses that achieved systemic exposures 48 to 58 times the exposure in patients treated with 50 mg etanercept once weekly [see *Data*].

All pregnancies have a background risk of birth defect, loss, or other adverse outcomes. The estimated background risk of major birth defects and miscarriage for the indicated populations is unknown. In the United States, about 2-4% of liveborn babies have a major birth defect and about 15-20% of pregnancies end in miscarriage, regardless of drug exposure.

#### *Clinical Considerations*

##### Fetal/Neonatal Adverse Reactions

The risk of fetal/neonatal adverse reactions with in utero exposure to etanercept is unknown. Risks and benefits should be considered prior to administering live or live-attenuated vaccines to infants exposed to etanercept in utero [see *Use in Specific Populations* (8.4)].



## *Data*

### *Human Data*

A prospective cohort pregnancy registry conducted by OTIS in the US and Canada between 2000 and 2012 compared the risk of major birth defects in liveborn infants of women with rheumatic diseases or another indication exposed to etanercept in the first trimester. The proportion of major birth defects among liveborn infants in the etanercept-exposed (N = 319) and diseased etanercept unexposed cohorts (N = 144) was 9.4% and 3.5%, respectively. The findings showed no statistically significant increased risk of minor birth defects and no pattern of major or minor birth defects.

A Scandinavian study compared the risk of major birth defects in liveborn infants of women with chronic inflammatory disease (CID) exposed to TNF-inhibitors during early pregnancy. Women were identified from the Danish (2004-2012) and Swedish (2006-2012) population based health registers. The proportion of major birth defects among liveborn infants in the etanercept-exposed (N=344) and CID etanercept unexposed cohorts (N = 21,549) was 7.0% and 4.7%, respectively.

Overall, while both the OTIS Registry and Scandinavian study show a higher proportion of major birth defects in etanercept-exposed patients compared to diseased etanercept unexposed patients, the lack of pattern of birth defects is reassuring and differences between exposure groups (e.g. disease severity) may have impacted the occurrence of birth defects.

Three case reports from the literature showed that cord blood levels of etanercept at delivery, in infants born to women administered etanercept during pregnancy, were between 3% and 32% of the maternal serum level.

### *Animal Data*

In embryofetal development studies with etanercept administered during the period of organogenesis to pregnant rats from gestation day (GD) 6 through 20 or pregnant rabbits from GD 6 through 18, there was no evidence of fetal malformations or embryotoxicity in rats or rabbits at respective doses that achieved systemic exposures 48 to 58 times the exposure in patients treated with 50 mg etanercept once weekly (on an AUC basis with maternal subcutaneous doses up to 30 mg/kg/day in rats and 40 mg/kg/day in rabbits). In a peri-and post-natal development study with pregnant rats that received etanercept during organogenesis and the later gestational period from GD 6 through 21, development of pups through post-natal day 4 was unaffected at doses that achieved exposures 48 times the exposure in patients treated with 50 mg etanercept once weekly (on an AUC basis with maternal subcutaneous doses up to 30 mg/kg/day).

## **8.2 Lactation**

### *Risk Summary*

Limited data from published literature show that etanercept is present in low levels in human milk and minimally absorbed by a breastfed infant. No data are available on the effects of etanercept on the breastfed child or the effects on milk production. The developmental and health benefits of breastfeeding should be considered along with the mother's clinical need for ERELZI and any potential adverse effects on the breastfed child from the drug or from the underlying maternal condition.

#### **8.4 Pediatric Use**

Etanercept has been studied in 69 children with moderately to severely active polyarticular JIA aged 2 to 17 years.

Etanercept has not been studied in children < 2 years of age with JIA. For pediatric specific safety information concerning malignancies and inflammatory bowel disease, [see *Warnings and Precautions* (5.3) and *Adverse Reactions* (6.2)].

The clinical significance of infant exposure to etanercept *in utero* is unknown. The safety of administering live or live-attenuated vaccines in exposed infants is unknown. Risks and benefits should be considered prior to administering live or live-attenuated vaccines to exposed infants. For pediatric specific safety information concerning vaccinations [see *Warnings and Precautions* (5.8) and *Drug Interactions* (7.1)].

#### **8.5 Geriatric Use**

A total of 480 RA patients ages 65 years or older have been studied in clinical trials. Because there is a higher incidence of infections in the elderly population in general, caution should be used in treating the elderly.

#### **8.6 Use in Diabetics**

There have been reports of hypoglycemia following initiation of etanercept therapy in patients receiving medication for diabetes, necessitating a reduction in anti-diabetic medication in some of these patients.

### **10 OVERDOSAGE**

No dose-limiting toxicities have been observed during clinical trials of etanercept. Single IV doses up to 60 mg/m<sup>2</sup> (approximately twice the recommended dose) have been administered to healthy volunteers in an endotoxemia study without evidence of dose-limiting toxicities.

### **11 DESCRIPTION**

ERELZI (etanercept-szszs), a tumor necrosis factor (TNF) blocker, is a dimeric fusion protein consisting of the extracellular ligand-binding portion of the human 75 kilodalton (p75) tumor necrosis factor receptor (TNFR) linked to the Fc portion of human IgG1. The Fc component of etanercept-szszs contains the C<sub>H</sub>2 domain, the C<sub>H</sub>3 domain and hinge region, but not the C<sub>H</sub>1 domain of IgG1. Etanercept-szszs is produced by recombinant DNA technology in a Chinese hamster ovary (CHO) mammalian cell expression system. It consists of 934 amino acids and has an apparent molecular weight of approximately 150 kilodaltons.

ERELZI (etanercept-szszs) Injection in the single-dose prefilled syringe with BD UltraSafe Passive Needle Guard and the single-dose prefilled Sensoready Pen is clear and colorless to slightly yellow, sterile, preservative-free, and is formulated at pH 6.3 ± 0.2. ERELZI is for subcutaneous use.

**Table 5. Contents of ERELZI**

Presentation	Active Ingredient Content	Inactive Ingredients Content
Etanercept-szszs 50 mg prefilled syringe with BD UltraSafe Passive Needle Guard and Sensoready Pen	50 mg etanercept-szszs in 1 mL	0.786 mg citric acid 13.52 mg sodium citrate 1.5 mg sodium chloride 10 mg sucrose 4.6 mg lysine
Etanercept-szszs 25 mg prefilled syringe with BD UltraSafe Passive Needle Guard	25 mg etanercept-szszs in 0.5 mL	0.393 mg citric acid 6.76 mg sodium citrate 0.75 mg sodium chloride 5 mg sucrose 2.3 mg lysine

## 12 CLINICAL PHARMACOLOGY

### 12.1 Mechanism of Action

TNF is a naturally occurring cytokine that is involved in normal inflammatory and immune responses. It plays an important role in the inflammatory processes of RA, polyarticular JIA, AS, and another indication and the resulting joint pathology. Elevated levels of TNF are found in involved tissues and fluids of patients with RA, JIA, AS, and two other indications.

Two distinct receptors for TNF (TNFRs), a 55 kilodalton protein (p55) and a 75 kilodalton protein (p75), exist naturally as monomeric molecules on cell surfaces and in soluble forms. Biological activity of TNF is dependent upon binding to either cell surface TNFR.

Etanercept products are dimeric soluble forms of the p75 TNF receptor that can bind TNF molecules. Etanercept products inhibit binding of TNF- $\alpha$  and TNF- $\beta$  (lymphotoxin alpha [LT- $\alpha$ ]) to cell surface TNFRs, rendering TNF biologically inactive. In *in vitro* studies, large complexes of etanercept with TNF- $\alpha$  were not detected and cells expressing transmembrane TNF (that binds etanercept products) are not lysed in the presence or absence of complement.

### 12.2 Pharmacodynamics

Etanercept products can modulate biological responses that are induced or regulated by TNF, including expression of adhesion molecules responsible for leukocyte migration (eg, E-selectin, and to a lesser extent, intercellular adhesion molecule-1 [ICAM-1]), serum levels of cytokines (eg, IL-6), and serum levels of matrix metalloproteinase-3 (MMP-3 or stromelysin). Etanercept products have been shown to affect several animal models of inflammation, including murine collagen-induced arthritis.

### 12.3 Pharmacokinetics

After administration of 25 mg of etanercept by a single SC injection to 25 patients with RA, a mean  $\pm$  standard deviation half-life of  $102 \pm 30$  hours was observed with a clearance of  $160 \pm 80$  mL/hr. A maximum serum concentration ( $C_{max}$ ) of  $1.1 \pm 0.6$  mcg/mL and time to  $C_{max}$  of  $69 \pm 34$  hours was observed in these patients following a single 25 mg dose. After 6 months of twice weekly 25 mg doses in these same RA patients, the mean  $C_{max}$  was  $2.4 \pm 1.0$  mcg/mL (N = 23).

Patients exhibited a 2- to 7-fold increase in peak serum concentrations and approximately 4-fold increase in AUC<sub>0-72 hr</sub> (range 1- to 17-fold) with repeated dosing. Serum concentrations in patients with RA have not been measured for periods of dosing that exceed 6 months.

In another study, serum concentration profiles at steady-state were comparable among patients with RA treated with 50 mg etanercept once weekly and those treated with 25 mg etanercept twice weekly. The mean ( $\pm$  standard deviation) C<sub>max</sub>, C<sub>min</sub>, and partial AUC were 2.4  $\pm$  1.5 mcg/mL, 1.2  $\pm$  0.7 mcg/mL, and 297  $\pm$  166 mcg•h/mL, respectively, for patients treated with 50 mg etanercept once weekly (N = 21); and 2.6  $\pm$  1.2 mcg/mL, 1.4  $\pm$  0.7 mcg/mL, and 316  $\pm$  135 mcg•h/mL for patients treated with 25 mg etanercept twice weekly (N = 16).

Patients with JIA (ages 4 to 17 years) were administered 0.4 mg/kg of etanercept twice weekly (up to a maximum dose of 50 mg per week) for up to 18 weeks. The mean serum concentration after repeated SC dosing was 2.1 mcg/mL, with a range of 0.7 to 4.3 mcg/mL. Limited data suggest that the clearance of etanercept is reduced slightly in children ages 4 to 8 years. Population pharmacokinetic analyses predict that the pharmacokinetic differences between the regimens of 0.4 mg/kg twice weekly and 0.8 mg/kg once weekly in JIA patients are of the same magnitude as the differences observed between twice weekly and weekly regimens in adult RA patients.

In clinical studies with etanercept, pharmacokinetic parameters were not different between men and women and did not vary with age in adult patients. The pharmacokinetics of etanercept were unaltered by concomitant MTX in RA patients. No formal pharmacokinetic studies have been conducted to examine the effects of renal or hepatic impairment on etanercept disposition.

## 13 NONCLINICAL TOXICOLOGY

### 13.1 Carcinogenesis, Mutagenesis, Impairment of Fertility

Long-term animal studies have not been conducted to evaluate the carcinogenic potential of etanercept products or their effect on fertility. Mutagenesis studies were conducted with etanercept *in vitro* and *in vivo*, and no evidence of mutagenic activity was observed.

## 14 CLINICAL STUDIES

### 14.1 Adult Rheumatoid Arthritis

The safety and efficacy of etanercept were assessed in four randomized, double-blind, controlled studies. The results of all four trials were expressed in percentage of patients with improvement in RA using ACR response criteria.

Study I evaluated 234 patients with active RA who were  $\geq$  18 years old, had failed therapy with at least one but no more than four disease-modifying antirheumatic drugs (DMARDs) (e.g., hydroxychloroquine, oral or injectable gold, MTX, azathioprine, D-penicillamine, sulfasalazine), and had  $\geq$  12 tender joints,  $\geq$  10 swollen joints, and either erythrocyte sedimentation rate (ESR)  $\geq$  28 mm/hr, C-reactive protein (CRP)  $>$  2.0 mg/dL, or morning stiffness for  $\geq$  45 minutes. Doses of 10 mg or 25 mg etanercept or placebo were administered SC twice a week for 6 consecutive months.

Study II evaluated 89 patients and had similar inclusion criteria to Study I except that patients in Study II had additionally received MTX for at least 6 months with a stable dose (12.5 to 25 mg/week) for at least 4 weeks and they had at least 6 tender or painful joints. Patients in Study II received a dose of 25 mg etanercept or placebo SC twice a week for 6 months in addition to their stable MTX dose.

Study III compared the efficacy of etanercept to MTX in patients with active RA. This study evaluated 632 patients who were  $\geq 18$  years old with early ( $\leq 3$  years disease duration) active RA, had never received treatment with MTX, and had  $\geq 12$  tender joints,  $\geq 10$  swollen joints, and either ESR  $\geq 28$  mm/hr, CRP  $> 2.0$  mg/dL, or morning stiffness for  $\geq 45$  minutes. Doses of 10 mg or 25 mg etanercept were administered SC twice a week for 12 consecutive months. The study was unblinded after all patients had completed at least 12 months (and a median of 17.3 months) of therapy. The majority of patients remained in the study on the treatment to which they were randomized through 2 years, after which they entered an extension study and received open-label 25 mg etanercept. MTX tablets (escalated from 7.5 mg/week to a maximum of 20 mg/week over the first 8 weeks of the trial) or placebo tablets were given once a week on the same day as the injection of placebo or etanercept doses, respectively.

Study IV evaluated 682 adult patients with active RA of 6 months to 20 years duration (mean of 7 years) who had an inadequate response to at least one DMARD other than MTX. Forty-three percent of patients had previously received MTX for a mean of 2 years prior to the trial at a mean dose of 12.9 mg. Patients were excluded from this study if MTX had been discontinued for lack of efficacy or for safety considerations. The patient baseline characteristics were similar to those of patients in Study I. Patients were randomized to MTX alone (7.5 to 20 mg weekly, dose escalated as described for Study III; median dose 20 mg), etanercept alone (25 mg twice weekly), or the combination of etanercept and MTX initiated concurrently (at the same doses as above). The study evaluated ACR response, Sharp radiographic score, and safety.

### Clinical Response

A higher percentage of patients treated with etanercept and etanercept in combination with MTX achieved ACR 20, ACR 50, and ACR 70 responses and Major Clinical Responses than in the comparison groups. The results of Studies I, II, and III are summarized in [Table 6](#). The results of Study IV are summarized in [Table 7](#).

**Table 6. ACR Responses in Placebo- and Active-Controlled Trials (Percent of Patients)**

Response	Placebo Controlled				Active Controlled	
	Study I		Study II		Study III	
	Placebo N=80	Etanercept <sup>a</sup> N= 78	MTX/Placebo N= 30	MTX/Etanercept <sup>a</sup> N= 59	MTX N= 217	Etanercept <sup>a</sup> N= 207
<b>ACR 20</b>						
Month 3	23%	62%	33%	66%	56%	62%
Month 6	11%	59%	27%	71%	58%	65%
Month 12	NA	NA	NA	NA	65%	72%
<b>ACR 50</b>						
Month 3	8%	41%	0%	42%	24%	29%
Month 6	5%	40%	3%	39%	32%	40%
Month 12	NA	NA	NA	NA	43%	49%
<b>ACR 70</b>						
Month 3	4%	15%	0%	15%	7%	13%
Month 6	1%	15%	0%	15%	14%	21%
Month 12	NA	NA	NA	NA	22%	25%

<sup>a</sup> 25 mg etanercept SC twice weekly

<sup>b</sup> p< 0.01, etanercept vs placebo

<sup>c</sup> p< 0.05, etanercept vs MTX

**Table 7. Study IV Clinical Efficacy Results: Comparison of MTX vs Etanercept vs Etanercept in Combination With MTX in Patients With Rheumatoid Arthritis of 6 Months to 20 Years Duration (Percent of Patients)**

Endpoint	MTX (N= 228)	Etanercept (N= 223)	Etanercept/MTX (N= 231)
<b>ACR N<sup>a,b</sup></b>			
Month 12	40%	47%	63% <sup>c</sup>
<b>ACR 20</b>			
Month 12	59%	66%	75% <sup>c</sup>
<b>ACR 50</b>			
Month 12	36%	43%	63% <sup>c</sup>
<b>ACR 70</b>			
Month 12	17%	22%	40% <sup>c</sup>
<b>Major Clinical Response<sup>d</sup></b>	6%	10%	24% <sup>c</sup>

<sup>a</sup>Values are medians.

<sup>b</sup>ACR N is the percent improvement based on the same core variables used in defining ACR 20, ACR 50, and ACR 70.

<sup>c</sup>p < 0.05 for comparisons of etanercept/MTX vs etanercept alone or MTX alone.

<sup>d</sup>Major clinical response is achieving an ACR 70 response for a continuous 6-month period.

The time course for ACR 20 response rates for patients receiving placebo or 25 mg etanercept in Studies I and II is summarized in Figure 1. The time course of responses to etanercept in Study III was similar.

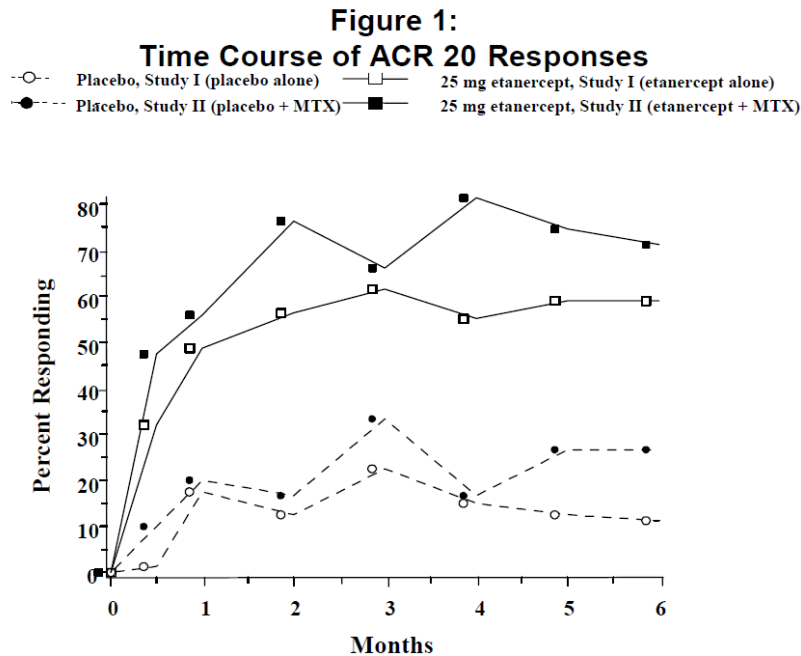

Among patients receiving etanercept, the clinical responses generally appeared within 1 to 2 weeks after initiation of therapy and nearly always occurred by 3 months. A dose response was seen in Studies I and III: 25 mg etanercept was more effective than 10 mg (10 mg was not evaluated in Study II). Etanercept was significantly better than placebo in all components of the ACR criteria as well as other measures of RA disease activity not included in the ACR response criteria, such as morning stiffness.

In Study III, ACR response rates and improvement in all the individual ACR response criteria were maintained through 24 months of etanercept therapy. Over the 2-year study, 23% of etanercept's patients achieved a major clinical response, defined as maintenance of an ACR 70 response over a 6-month period.

The results of the components of the ACR response criteria for Study I are shown in [Table 8](#). Similar results were observed for etanercept-treated patients in Studies II and III.

**Table 8. Components of ACR Response in Study I**

Parameter (median)	Placebo N=80		Etanercept <sup>a</sup> N=78	
	Baseline	3 Months	Baseline	3 Months <sup>*</sup>
Number of tender joints <sup>b</sup>	34.0	29.5	31.2	10.0 <sup>f</sup>
Number of swollen joints <sup>c</sup>	24.0	22.0	23.5	12.6 <sup>f</sup>
Physician global assessment <sup>d</sup>	7.0	6.5	7.0	3.0 <sup>f</sup>
Patient global assessment <sup>d</sup>	7.0	7.0	7.0	3.0 <sup>f</sup>
Pain <sup>d</sup>	6.9	6.6	6.9	2.4 <sup>f</sup>
Disability index <sup>e</sup>	1.7	1.8	1.6	1.0 <sup>f</sup>
ESR (mm/hr)	31.0	32.0	28.0	15.5 <sup>f</sup>
CRP (mg/dL)	2.8	3.9	3.5	0.9 <sup>f</sup>

<sup>\*</sup>Results at 6 months showed similar improvement.

<sup>a</sup>25 mg etanercept SC twice weekly.

<sup>b</sup>Scale 0-71.

<sup>c</sup>Scale 0-68.

<sup>d</sup>Visual analog scale: 0 = best; 10 = worst.

<sup>e</sup>Health Assessment Questionnaire: 0 = best; 3 = worst; includes eight categories: dressing and grooming, arising, eating, walking, hygiene, reach, grip, and activities.

<sup>f</sup>p < 0.01, etanercept vs placebo, based on mean percent change from baseline.

After discontinuation of etanercept, symptoms of arthritis generally returned within a month. Reintroduction of treatment with etanercept after discontinuations of up to 18 months resulted in the same magnitudes of response as in patients who received etanercept without interruption of therapy, based on results of open-label studies.

Continued durable responses were seen for over 60 months in open-label extension treatment trials when patients received etanercept without interruption. A substantial number of patients who initially received concomitant MTX or corticosteroids were able to reduce their doses or discontinue these concomitant therapies while maintaining their clinical responses.

### Physical Function Response

In Studies I, II, and III, physical function and disability were assessed using the Health Assessment Questionnaire (HAQ). Additionally, in Study III, patients were administered the SF-36 Health Survey. In Studies I and II, patients treated with 25 mg etanercept twice weekly showed greater improvement from baseline in the HAQ score beginning in month 1 through month 6 in comparison to placebo (p < 0.001) for the HAQ disability domain (where 0 = none and 3 = severe). In Study I, the mean improvement in the HAQ score from baseline to month 6 was 0.6 (from 1.6 to 1.0) for the 25 mg etanercept group and 0 (from 1.7 to 1.7) for the placebo group. In Study II, the mean improvement from baseline to month 6 was 0.6 (from 1.5 to 0.9) for the etanercept /MTX group and 0.2 (from 1.3 to 1.2) for the placebo/MTX group. In Study III, the mean improvement in the HAQ score from baseline to month 6 was 0.7 (from 1.5 to 0.7) for



25 mg etanercept twice weekly. All subdomains of the HAQ in Studies I and III were improved in patients treated with etanercept.

In Study III, patients treated with 25 mg etanercept twice weekly showed greater improvement from baseline in SF-36 physical component summary score compared to etanercept 10 mg twice weekly and no worsening in the SF-36 mental component summary score. In open-label studies of etanercept, improvements in physical function and disability measures have been maintained for up to 4 years.

In Study IV, median HAQ scores improved from baseline levels of 1.8, 1.8, and 1.8 to 1.1, 1.0, and 0.6 at 12 months in the MTX, etanercept, and etanercept /MTX combination treatment groups, respectively (combination versus both MTX and etanercept,  $p < 0.01$ ). Twenty-nine percent of patients in the MTX alone treatment group had an improvement of HAQ of at least 1 unit versus 40% and 51% in etanercept alone and etanercept /MTX combination treatment groups, respectively.

#### Radiographic Response

In Study III, structural joint damage was assessed radiographically and expressed as change in Total Sharp Score (TSS) and its components, the erosion score and joint space narrowing (JSN) score. Radiographs of hands/wrists and forefeet were obtained at baseline, 6 months, 12 months, and 24 months and scored by readers who were unaware of treatment group. The results are shown in Table 9. A significant difference for change in erosion score was observed at 6 months and maintained at 12 months.

**Table 9. Mean Radiographic Change Over 6 and 12 Months in Study III**

		<b>MTX</b>	<b>25 mg Etanercept</b>	<b>MTX/Etanercept (95% Confidence Interval*)</b>	<b>P Value</b>
12 Months	Total Sharp Score	1.59	1.00	0.59 (-0.12, 1.30)	0.1
	Erosion Score	1.03	0.47	0.56 (0.11, 1.00)	0.002
	JSN Score	0.56	0.52	0.04 (-0.39, 0.46)	0.5
6 Months	Total Sharp Score	1.06	0.57	0.49 (0.06, 0.91)	0.001
	Erosion Score	0.68	0.30	0.38 (0.09, 0.66)	0.001
	JSN Score	0.38	0.27	0.11 (-0.14, 0.35)	0.6

\* 95% confidence intervals for the differences in change scores between MTX and etanercept.

Patients continued on the therapy to which they were randomized for the second year of Study III. Seventy-two percent of patients had x-rays obtained at 24 months. Compared to the patients in the MTX group, greater inhibition of progression in TSS and erosion score was seen in the 25 mg etanercept group, and, in addition, less progression was noted in the JSN score.

In the open-label extension of Study III, 48% of the original patients treated with 25 mg etanercept have been evaluated radiographically at 5 years. Patients had continued inhibition of structural damage, as measured by the TSS, and 55% of them had no progression of structural damage. Patients originally treated with MTX had further reduction in radiographic progression once they began treatment with etanercept.

In Study IV, less radiographic progression (TSS) was observed with etanercept in combination with MTX compared with etanercept alone or MTX alone at month 12 (Table 10). In the MTX treatment group, 55% of patients experienced no radiographic progression (TSS change  $\leq 0.0$ ) at 12 months compared to 63% and 76% in etanercept alone and etanercept /MTX combination treatment groups, respectively.

**Table 10. Mean Radiographic Change in Study IV at 12 Months (95% Confidence Interval)**

	<b>MTX (N=212)</b>	<b>Etanercept (N=212)*</b>	<b>Etanercept/MTX (N=218)*</b>
Total Sharp Score (TSS)	2.80	0.52 <sup>a</sup>	-0.54 <sup>b,c</sup>
	(1.08, 4.51)	(-0.10, 1.15)	(-1.00, -0.07)
Erosion Score (ES)	1.68	0.21 <sup>a</sup>	-0.30 <sup>b</sup>
	(0.61, 2.74)	(-0.20, 0.61)	(-0.65, 0.04)
Joint Space Narrowing (JSN) Score	1.12	0.32	-0.23 <sup>b,c</sup>
	(0.34, 1.90)	(0.00, 0.63)	(-0.45, -0.02)

\*Analyzed radiographic ITT population.

<sup>a</sup>p < 0.05 for comparison of etanercept vs MTX.

<sup>b</sup>p < 0.05 for comparison of etanercept/MTX vs MTX.

<sup>c</sup>p < 0.05 for comparison of etanercept/MTX vs etanercept.

### Once Weekly Dosing

The safety and efficacy of 50 mg etanercept (two 25 mg SC injections) administered once weekly were evaluated in a double-blind, placebo-controlled study of 420 patients with active RA. Fifty-three patients received placebo, 214 patients received 50 mg etanercept once weekly, and 153 patients received 25 mg etanercept twice weekly. The safety and efficacy profiles of the two etanercept treatment groups were similar.

### **14.2 Polyarticular Juvenile Idiopathic Arthritis (JIA)**

The safety and efficacy of etanercept were assessed in a 2-part study in 69 children with polyarticular JIA who had a variety of JIA onset types. Patients ages 2 to 17 years with moderately to severely active polyarticular JIA refractory to or intolerant of MTX were enrolled; patients remained on a stable dose of a single nonsteroidal anti-inflammatory drug and/or prednisone ( $\leq 0.2$  mg/kg/day or 10 mg maximum). In part 1, all patients received 0.4 mg/kg (maximum 25 mg per dose) etanercept SC twice weekly. In part 2, patients with a clinical response at day 90 were randomized to remain on etanercept or receive placebo for 4 months and assessed for disease flare. Responses were measured using the JIA Definition of Improvement

(DOI), defined as  $\geq 30\%$  improvement in at least three of six and  $\geq 30\%$  worsening in no more than one of the six JIA core set criteria, including active joint count, limitation of motion, physician and patient/parent global assessments, functional assessment, and ESR. Disease flare was defined as a  $\geq 30\%$  worsening in three of the six JIA core set criteria and  $\geq 30\%$  improvement in not more than one of the six JIA core set criteria and a minimum of two active joints.

In part 1 of the study, 51 of 69 (74%) patients demonstrated a clinical response and entered part 2. In part 2, 6 of 25 (24%) patients remaining on etanercept experienced a disease flare compared to 20 of 26 (77%) patients receiving placebo ( $p = 0.007$ ). From the start of part 2, the median time to flare was  $\geq 116$  days for patients who received etanercept and 28 days for patients who received placebo. Each component of the JIA core set criteria worsened in the arm that received placebo and remained stable or improved in the arm that continued on etanercept. The data suggested the possibility of a higher flare rate among those patients with a higher baseline ESR. Of patients who demonstrated a clinical response at 90 days and entered part 2 of the study, some of the patients remaining on etanercept continued to improve from month 3 through month 7, while those who received placebo did not improve.

The majority of JIA patients who developed a disease flare in part 2 and reintroduced etanercept treatment up to 4 months after discontinuation re-responded to etanercept therapy in open-label studies. Most of the responding patients who continued etanercept therapy without interruption have maintained responses for up to 48 months.

Studies have not been done in patients with polyarticular JIA to assess the effects of continued etanercept therapy in patients who do not respond within 3 months of initiating etanercept therapy, or to assess the combination of etanercept with MTX.

### **14.3 Ankylosing Spondylitis**

The safety and efficacy of etanercept were assessed in a randomized, double-blind, placebo-controlled study in 277 patients with active AS. Patients were between 18 and 70 years of age and had AS as defined by the modified New York Criteria for Ankylosing Spondylitis. Patients were to have evidence of active disease based on values of  $\geq 30$  on a 0-100 unit Visual Analog Scale (VAS) for the average of morning stiffness duration and intensity, and two of the following three other parameters: a) patient global assessment, b) average of nocturnal and total back pain, and c) the average score on the Bath Ankylosing Spondylitis Functional Index (BASFI). Patients with complete ankylosis of the spine were excluded from study participation. Patients taking hydroxychloroquine, sulfasalazine, methotrexate, or prednisone ( $\leq 10$  mg/day) could continue these drugs at stable doses for the duration of the study. Doses of 25 mg etanercept or placebo were administered SC twice a week for 6 months.

The primary measure of efficacy was a 20% improvement in the Assessment in Ankylosing Spondylitis (ASAS) response criteria. Compared to placebo, treatment with etanercept resulted in improvements in the ASAS and other measures of disease activity (Figure 2 and [Table 12](#)).

**Figure 2. ASAS 20 Responses in Ankylosing Spondylitis**

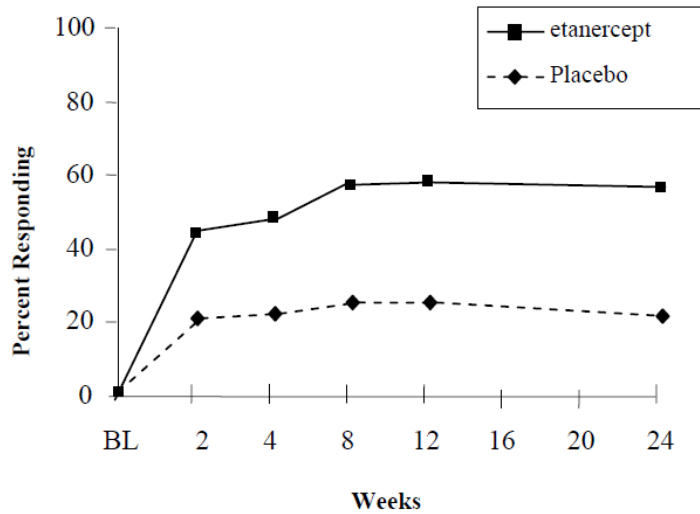

At 12 weeks, the ASAS 20/50/70 responses were achieved by 60%, 45%, and 29%, respectively, of patients receiving etanercept, compared to 27%, 13%, and 7%, respectively, of patients receiving placebo ( $p \leq 0.0001$ , etanercept vs placebo). Similar responses were seen at Week 24. Responses were similar between those patients receiving concomitant therapies at baseline and those who were not. The results of this study were similar to those seen in a single-center, randomized, placebo-controlled study of 40 patients and a multicenter, randomized, placebo-controlled study of 84 patients with AS.

**Table 12. Components of Ankylosing Spondylitis Disease Activity**

	Placebo N=139		Etanercept <sup>a</sup> N=138	
	Baseline	6 Months	Baseline	6 Months
Median values at time points				
ASAS response criteria				
Patient global assessment <sup>b</sup>	63	56	63	36
Back pain <sup>c</sup>	62	56	60	34
BASFI <sup>d</sup>	56	55	52	36
Inflammation <sup>e</sup>	64	57	61	33
Acute phase reactants				
CRP (mg/dL) <sup>f</sup>	2.0	1.9	1.9	0.6
Spinal mobility (cm):				
Modified Schober's test	3.0	2.9	3.1	3.3
Chest expansion	3.2	3.0	3.3	3.9
Occiput-to-wall measurement	5.3	6.0	5.6	4.5

<sup>a</sup>p < 0.0015 for all comparisons between etanercept and placebo at 6 months. P values for continuous endpoints were based on percent change from baseline.

<sup>b</sup>Measured on a Visual Analog Scale (VAS) with 0 = "none" and 100 = "severe".

<sup>c</sup>Average of total nocturnal and back pain scores, measured on a VAS with 0 = "no pain" and 100 = "most severe pain".

<sup>d</sup>Bath Ankylosing Spondylitis Functional Index (BASFI), average of 10 questions.

<sup>e</sup>Inflammation represented by the average of the last 2 questions on the 6-question Bath Ankylosing Spondylitis Disease Activity Index (BASDAI).

<sup>f</sup>C-reactive protein (CRP) normal range: 0-1.0 mg/dL.

## 15 REFERENCES

1. National Cancer Institute. Surveillance, Epidemiology, and End Results Database (SEER) Program. SEER Incidence Crude Rates, 13 Registries, 1992-2002.

## 16 HOW SUPPLIED/STORAGE AND HANDLING

Administration of one 50 mg ERELZI prefilled syringe with BD UltraSafe Passive Needle Guard or one ERELZI Sensoready Pen provides a dose equivalent to two 25 mg ERELZI prefilled syringes with BD UltraSafe Passive Needle Guard.

### **ERELZI Prefilled Syringe with BD UltraSafe Passive Needle Guard and ERELZI Prefilled Sensoready Pen**

Each ERELZI (etanercept-szszs) Injection single-dose prefilled syringe with BD UltraSafe Passive Needle Guard and ERELZI single-dose prefilled Sensoready Pen contains clear and

colorless to slightly yellow solution containing 25 mg/0.5 mL or 50 mg/mL of etanercept-szszs in a single-dose syringe with a 27-gauge, ½-inch needle.

<b>50 mg/mL</b> single-dose prefilled syringe	Carton of 4	NDC 61314-821-04
<b>50 mg/mL</b> single-dose prefilled Sensoready Pen	Carton of 4	NDC 61314-832-04
<b>25 mg/0.5 mL</b> single-dose prefilled syringe	Carton of 4	NDC 61314-843-04

ERELZI should be refrigerated at 36°F to 46°F (2°C to 8°C). Do not use ERELZI beyond the expiration date stamped on the carton or barrel label. DO NOT SHAKE. Store ERELZI in the original carton to protect from light or physical damage.

For convenience, storage of individual syringes or Sensoready Pens at room temperature between 68°F to 77°F (20°C to 25°C) for a maximum single period of 28 days is permissible, with protection from light and sources of heat. Once a syringe or Sensoready Pen has been stored at room temperature, it should not be placed back into the refrigerator. If not used within 28 days at room temperature, the syringe or Sensoready Pens should be discarded. Do not store ERELZI in extreme heat or cold. DO NOT FREEZE. Keep out of the reach of children.

## **17 PATIENT COUNSELING INFORMATION**

Advise the patient to read FDA-approved patient labeling (*Medication Guide and Instructions for Use*) before the patient starts using ERELZI, and each time the prescription is renewed, as there may be new information they need to know.

Patients or their caregivers should be provided the ERELZI “Medication Guide” and provided an opportunity to read it and ask questions prior to initiation of therapy. The healthcare provider should ask the patient questions to determine any risk factors for treatment. Patients developing signs and symptoms of infection should seek medical evaluation immediately.

### **Patient Counseling**

Patients should be advised of the potential benefits and risks of ERELZI. Physicians should instruct their patients to read the Medication Guide before starting ERELZI therapy and to reread each time the prescription is renewed.

### Infections

Inform patients that ERELZI may lower the ability of their immune system to fight infections. Advise patients of the importance of contacting their doctor if they develop any symptoms of infection, tuberculosis or reactivation of hepatitis B virus infections.

### Other Medical Conditions

Advise patients to report any signs of new or worsening medical conditions, such as central nervous system demyelinating disorders, heart failure or autoimmune disorders, such as lupus-like syndrome or autoimmune hepatitis. Counsel about the risk of lymphoma and other

malignancies while receiving ERELZI. Advise patients to report any symptoms suggestive of a pancytopenia, such as bruising, bleeding, persistent fever or pallor.

### Allergic Reactions

Advise patients to seek immediate medical attention if they experience any symptoms of severe allergic reactions. Advise latex-sensitive patients that the following components contain dry natural rubber (a derivative of latex) that may cause allergic reactions in individuals sensitive to latex: the needle cap of the prefilled syringe and the internal needle cover within the cap of the Sensoready Pen.

### **Administration of ERELZI**

If a patient or caregiver is to administer ERELZI, the patient or caregiver should be instructed in injection techniques and how to measure and administer the correct dose [see the ERELZI (etanercept-szss) “Instructions for Use” insert]. The first injection should be performed under the supervision of a qualified healthcare professional. The patient’s or caregiver’s ability to inject subcutaneously should be assessed. Patients and caregivers should be instructed in the technique, as well as proper syringe and needle disposal, and be cautioned against reuse of needles and syringes.

When using the Sensoready Pen to administer ERELZI, the patient or caregiver should be informed that the window turns green when the injection is complete. After removing the Sensoready Pen, if the window has not turned green, or if it looks like the medicine is still injecting, this means the patient has not received a full dose. The patient or caregiver should be advised to call their healthcare provider immediately.

A puncture-resistant container for disposal of needles, syringes and Sensoready Pens should be used.

Manufactured by:  
Sandoz Inc.  
Princeton, NJ 08540  
US License No. 2003

At:  
Novartis Pharma AG  
Stein, Switzerland  
Product of Austria

Enbrel is a registered trademark of Immunex Corporation.  
UltraSafe Passive is a registered trademark of Safety Syringes, Inc.

**Medication Guide**  
**ERELZI (eh rel' zee)**  
**(etanercept-szsz)**  
**injection, for Subcutaneous Use**

Read the Medication Guide that comes with ERELZI before you start using it and each time you get a refill. There may be new information. This Medication Guide does not take the place of talking with your healthcare provider about your medical condition or treatment. It is important to remain under your healthcare provider's care while using ERELZI. ERELZI is a prescription medicine called a Tumor Necrosis Factor (TNF) blocker that affects your immune system.

**What is the most important information I should know about ERELZI?**

ERELZI may cause serious side effects, including:

1. Risk of Infection
2. Risk of Cancer

**1. Risk of Infection**

ERELZI can lower the ability of your immune system to fight infections. Some people have serious infections while taking etanercept products. These infections include tuberculosis (TB), and infections caused by viruses, fungi, or bacteria that spread throughout their body. Some people have died from these infections.

- Your healthcare provider should test you for TB before starting ERELZI.
- Your healthcare provider should monitor you closely for symptoms of TB during treatment with ERELZI even if you tested negative for TB.
- Your healthcare provider should check you for symptoms of any type of infection before, during, and after your treatment with ERELZI.

You should not start taking ERELZI if you have any kind of infection unless your healthcare provider says it is okay.

**2. Risk of Cancer**

- There have been cases of unusual cancers in children and teenage patients who started using TNF-blocking agents at less than 18 years of age.
- For children, teenagers, and adults taking TNF-blocker medicines, including ERELZI, the chances of getting lymphoma or other cancers may increase.
- People with rheumatoid arthritis or psoriasis, especially those with very active disease, may be more likely to get lymphoma.

**Before starting ERELZI, be sure to talk to your healthcare provider:**

ERELZI may not be right for you. Before starting ERELZI, tell your healthcare provider about all of your medical conditions, including:

**Infections. Tell your healthcare provider if you:**

- have an infection. See **“What is the most important information I should know about ERELZI?”**
- are being treated for an infection.
- think you have an infection.
- have symptoms of an infection such as fever, sweats or chills, cough or flu-like symptoms, shortness of breath, blood in your phlegm, weight loss, muscle aches, warm, red or painful areas on your skin, sores on your body, diarrhea or stomach pain, burning when you urinate or urinating more often than normal, and feel very tired.
- have any open cuts on your body.
- get a lot of infections or have infections that keep coming back.
- have diabetes, HIV, or a weak immune system. People with these conditions have a higher chance for infections.
- have TB, or have been in close contact with someone with TB.
- were born in, lived in, or traveled to countries where there is a risk for getting TB. Ask your healthcare provider if you are not sure.
- live, have lived in, or traveled to certain parts of the country (such as the Ohio and Mississippi River valleys, or the Southwest) where there is a greater risk for getting certain kinds of fungal infections (histoplasmosis, coccidioidomycosis, blastomycosis). These infections may happen or become more severe if you use ERELZI. Ask your healthcare provider if you do not know if you live or have lived in an area where these infections are common.
- have or have had hepatitis B.

**Also, before starting ERELZI, tell your healthcare provider:**

- **About all the medicines you take including prescription and over-the-counter medicines, vitamins and herbal supplements including:**
  - **Orencia® (abatacept) or Kineret® (anakinra).** You have a higher chance for serious infections when taking



- ERELZI with Orencia® or Kineret®.
- **Cyclophosphamide (Cytoxan®).** You may have a higher chance for getting certain cancers when taking ERELZI with cyclophosphamide.
- **Anti-diabetic medicines.** If you have diabetes and are taking medication to control your diabetes, your healthcare provider may decide you need less anti-diabetic medicine while taking ERELZI.

Keep a list of all your medications with you to show your healthcare provider and pharmacist each time you get a new medicine. Ask your healthcare provider if you are not sure if your medicine is one listed above.

**Other important medical information you should tell your healthcare provider before starting ERELZI, includes if you:**

- have or had a nervous system problem such as multiple sclerosis or Guillain-Barré syndrome.
- have or had heart failure.
- are scheduled to have surgery.
- have recently received or are scheduled to receive a vaccine.
  - All vaccines should be brought up-to-date before starting ERELZI.
  - People taking ERELZI should not receive live vaccines.
  - Ask your healthcare provider if you are not sure if you received a live vaccine.
- are allergic to rubber or latex.
  - The internal needle cover within the cap of the Sensoready® Pen and the needle cap of the prefilled syringe contains latex.
- have been around someone with varicella zoster (chicken pox).
- are pregnant or plan to become pregnant. It is not known if ERELZI will harm your unborn baby. If you took ERELZI during pregnancy, talk to your healthcare provider prior to the administration of live vaccines to your infant.
- are breastfeeding or plan to breastfeed. ERELZI can pass into breast milk. Talk to your healthcare provider about the best way to feed your baby while taking ERELZI.

See **“What are the possible side effects of ERELZI?”** below for more information.

#### **What is ERELZI?**

ERELZI is a prescription medicine called a Tumor Necrosis Factor (TNF) blocker.

ERELZI is used to treat:

- moderately to severely active rheumatoid arthritis (RA). ERELZI can be used alone or with a medicine called methotrexate.
- moderately to severely active polyarticular juvenile idiopathic arthritis (JIA) in children ages 2 years and older.
- ankylosing spondylitis (AS).

You may continue to use other medicines that help treat your condition while taking ERELZI, such as nonsteroidal anti-inflammatory drugs (NSAIDs) and prescription steroids, as recommended by your healthcare provider.

ERELZI can help reduce joint damage and the signs and symptoms of the above mentioned diseases. People with these diseases have too much of a protein called tumor necrosis factor (TNF), which is made by your immune system. ERELZI can reduce the effect of TNF in the body and block the damage that too much TNF can cause, but it can also lower the ability of your immune system to fight infections. See **“What is the most important information I should know about ERELZI?”** and **“What are the possible side effects of ERELZI?”**

#### **Who should not use ERELZI?**

**Do not use ERELZI if you:**

- have an infection that has spread through your body (sepsis).

#### **How should I use ERELZI?**

- ERELZI is given as an injection under the skin (subcutaneous or SC).
- If your healthcare provider decides that you or a caregiver can give the injections of ERELZI at home, you or your caregiver should receive training on the right way to prepare and inject ERELZI. Do not try to inject ERELZI until you have been shown the right way by your healthcare provider or nurse.
- ERELZI is available in the forms listed below. Your healthcare provider will prescribe the type that is best for you.
  - Single-dose Prefilled Syringe
  - Single-dose Prefilled Sensoready® Pen
- See the Instructions for Use that come with ERELZI for detailed instructions about the right way to store, prepare, and give your ERELZI injections at home.
- Your healthcare provider will tell you how often you should use ERELZI. Do not miss any doses of ERELZI. If you forget to use ERELZI, inject your dose as soon as you remember. Then, take your next dose at your regular(ly) scheduled time. In case you are not sure when to inject ERELZI, call your healthcare provider or pharmacist. **Do not use ERELZI more often than as directed by your healthcare provider.**

- Your child's dose of ERELZI depends on his or her weight. Your child's healthcare provider will tell you which form of ERELZI to use and how much to give your child.

#### **What are the possible side effects of ERELZI?**

##### **ERELZI can cause serious side effects including:**

- See **"What is the most important information I should know about ERELZI?"**
- **Infections.** ERELZI can make you more likely to get infections or make any infection that you have worse. Call your healthcare provider right away if you have any symptoms of an infection. See **"Before starting ERELZI, be sure to talk to your healthcare provider"** for a list of symptoms of infection.
- **Previous Hepatitis B infection.** If you have been previously infected with the hepatitis B virus (a virus that affects the liver), the virus can become active while you use ERELZI. Your doctor may do a blood test before you start treatment with ERELZI and while you use ERELZI.
- **Nervous system problems.** Rarely, people who use TNF-blocker medicines have developed nervous system problems such as multiple sclerosis, seizures, or inflammation of the nerves of the eyes. Tell your healthcare provider right away if you get any of these symptoms: numbness or tingling in any part of your body, vision changes, weakness in your arms and legs, and dizziness.
- **Blood problems.** Low blood counts have been seen with other TNF-blocker medicines. Your body may not make enough of the blood cells that help fight infections or help stop bleeding. Symptoms include fever, bruising or bleeding very easily, or looking pale.
- **Heart failure including new heart failure or worsening of heart failure you already have.** New or worse heart failure can happen in people who use TNF-blocker medicines like ERELZI. If you have heart failure your condition should be watched closely while you take ERELZI. Call your healthcare provider right away if you get new or worsening symptoms of heart failure while taking ERELZI, such as shortness of breath or swelling of your lower legs or feet.
- **Psoriasis.** Some people using etanercept products developed new psoriasis or worsening of psoriasis they already had. Tell your healthcare provider if you develop red scaly patches or raised bumps that may be filled with pus. Your healthcare provider may decide to stop your treatment with ERELZI.
- **Allergic reactions.** Allergic reactions can happen to people who use TNF-blocker medicines. Call your healthcare provider right away if you have any symptoms of an allergic reaction. Symptoms of an allergic reaction include a severe rash, a swollen face, or trouble breathing.
- **Autoimmune reactions, including:**
  - **Lupus-like syndrome.** Symptoms include a rash on your face and arms that gets worse in the sun. Tell your healthcare provider if you have this symptom. Symptoms may go away when you stop using ERELZI.
  - **Autoimmune hepatitis.** Liver problems can happen in people who use TNF-blocker medicines, including ERELZI. These problems can lead to liver failure and death. Call your healthcare provider right away if you have any of these symptoms: feel very tired, skin or eyes look yellow, poor appetite or vomiting, pain on the right side of your stomach (abdomen).

##### **Common side effects of ERELZI include:**

- **Injection site reactions** such as redness, swelling, itching, or pain. These symptoms usually go away within 3 to 5 days. If you have pain, redness, or swelling around the injection site that does not go away or gets worse, call your healthcare provider.
- **Upper respiratory infections** (sinus infections).
- **Headache.**

These are not all the side effects with ERELZI. Tell your healthcare provider about any side effect that bothers you or does not go away.

Call your doctor for medical advice about side effects. You may report side effects to FDA at 1-800-FDA-1088.

**How should I store ERELZI?**

- Store ERELZI in the refrigerator between 36°F to 46°F (2°C to 8°C).
- Store ERELZI in the original carton to protect from light or physical damage.
- If needed, you may store the ERELZI prefilled syringe or pen, at room temperature between 68°F to 77°F (20°C to 25°C) for up to 28 days.
  - Once ERELZI has reached room temperature, do not put it back in the refrigerator.
- Throw away ERELZI that has been stored at room temperature after 28 days.
- **Do not** take ERELZI if the expiration date on the carton or barrel label of the prefilled syringe or pen has passed. Throw away ERELZI if the expiration date has passed.
- **Do not** store ERELZI in extreme heat or cold such as in your vehicle's glove box or trunk.
- **Do not freeze.**
- **Do not shake.**
- Keep ERELZI and all medicines out of the reach of children.

**General information about the safe and effective use of ERELZI.**

Medicines are sometimes prescribed for purposes not mentioned in a Medication Guide. Do not use ERELZI for a condition for which it was not prescribed. Do not give ERELZI to other people, even if they have the same condition. It may harm them.

This Medication Guide summarizes the most important information about ERELZI. If you would like more information, talk with your healthcare provider. You can ask your healthcare provider or pharmacist for information about ERELZI that was written for healthcare professionals.

**What are the ingredients in ERELZI?****Single-dose Prefilled Syringe and the Single-dose Prefilled Sensoready® Pen:**

**Active Ingredient:** etanercept-szzs

**Inactive Ingredients:** sodium citrate, sucrose, sodium chloride, lysine, citric acid

Manufactured by: Sandoz Inc. Princeton, NJ 08540. US License No. 2003

At: Novartis Pharma AG. Stein, Switzerland. Product of Austria.

For more information, go to [www.ERELZI.com](http://www.ERELZI.com) or call 1-800-252-8747.

This Medication Guide has been approved by the U.S. Food and Drug Administration

Issued: 01/2018

**Instructions for Use**  
**ERELZI (eh rel' zee)**  
**(etanercept-szszs)**  
**Sensoready® Pen**

Be sure that you read, understand, and follow this Instructions for Use before injecting ERELZI. Your healthcare provider should show you how to prepare and inject ERELZI properly using the ERELZI Sensoready Pen before you use it for the first time. Talk to your healthcare provider if you have any questions.

**Important:**

- **Do not use** the ERELZI Sensoready Pen if either the seal on the outer carton or the seal on the pen is broken. Keep the ERELZI Sensoready Pen in the sealed outer carton until you are ready to use it.
- Inject ERELZI 15 to 30 minutes after taking it out of the refrigerator.
- **Do not shake** the ERELZI Sensoready Pen.
- **The internal needle cover within the cap of the ERELZI Sensoready Pen contains latex. Do not handle the ERELZI Sensoready Pen if you are sensitive to latex.**
- If you drop your ERELZI Sensoready Pen, **do not use** it if the ERELZI Sensoready Pen looks damaged, or if you dropped it with the cap removed.
- Throw away (dispose of) the used ERELZI Sensoready Pen right away after use. **Do not reuse a ERELZI Sensoready Pen.** See “**How should I dispose of used ERELZI Sensoready Pens?**” at the end of this Instructions for Use.

**How should I store ERELZI?**

- Store your carton of ERELZI Sensoready Pens in the refrigerator, between 36°F to 46°F (2°C to 8°C).
- If needed, you may store the ERELZI Sensoready Pen at room temperature between 68°F to 77°F (20°C to 25°C) for up to 28 days. Once the ERELZI Sensoready Pen has reached room temperature, do not put it back into the refrigerator. Throw away the ERELZI Sensoready Pen that has been stored at room temperature after 28 days.
- Keep ERELZI Sensoready Pen in the original carton until ready to use to protect from light.
- Do not store ERELZI in extreme heat or cold such as in your vehicle’s glove box or trunk.
- Do not freeze ERELZI Sensoready Pen.

**Keep ERELZI and all medicines out of the reach of children.**

ERELZI Sensoready Pen parts (see **Figure A**):

**Figure A**

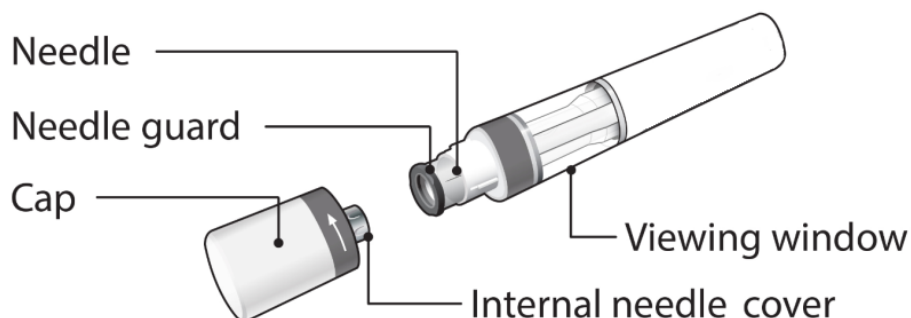

The ERELZI Sensoready Pen is shown above with the cap removed. **Do not** remove the cap until you are ready to inject.

### What you need for your injection:

Included in your carton:

A new ERELZI Sensoready Pen (see **Figure B**).

Each ERELZI Sensoready Pen contains 50 mg/mL of ERELZI.

**Figure B**

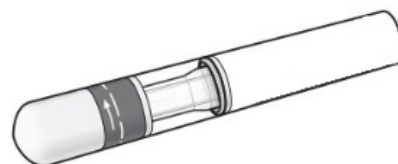

Not included in your carton (see **Figure C**):

- 1 Alcohol wipe
- 1 Cotton ball or gauze
- Sharps disposal container
- 1 Adhesive bandage

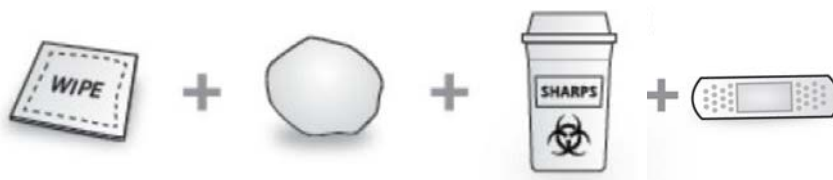

**Figure C**

See “**How should I dispose of used ERELZI Sensoready Pen?**” at the end of this Instructions for Use.

### Before your injection:

Take the ERELZI Sensoready Pen out of the refrigerator **15 to 30 minutes before injecting** to allow it to reach room temperature. **Do not** try to warm the ERELZI Sensoready Pen by using a heat source such as hot water or a microwave.

### Step 1. Important safety checks before you inject (see **Figure D**):

- Look through the viewing window. The liquid should be clear and colorless to slightly yellow. It is normal to see small white particles in the liquid. **Do not use** if the liquid is cloudy, discolored, or has large lumps, flakes, or particles in it. Return the ERELZI Sensoready Pen and the package it came in to your pharmacy. Contact your pharmacist if you are concerned about how the liquid in your ERELZI Sensoready Pen looks.
- Look at the **expiration date (EXP)** on your ERELZI Sensoready Pen. **Do not** use your ERELZI Sensoready Pen if the expiration date has passed. If the expiration date has passed, return the ERELZI Sensoready Pen and the package it came in to your pharmacy.

**Figure D**

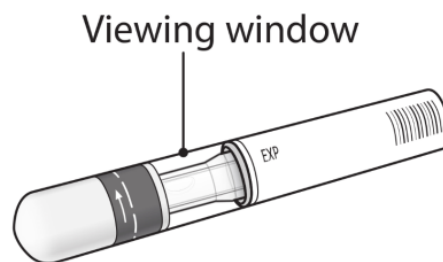

**Contact your pharmacist if the ERELZI Sensoready Pen fails any of these checks.**

## Step 2. Choose your injection site:

- The recommended site is the front of the thighs. You may also use the lower abdomen, but **not** the area 2 inches (5 cm) around your navel (belly button) (see **Figure E**).
- Choose a different site each time you give yourself an injection.
- Do not inject into areas where the skin is tender, bruised, red, scaly, or hard. Avoid areas with scars or stretch marks. If you have psoriasis, **do not** inject directly into any raised, thick, red, or scaly skin patches or lesions.

**Figure E**

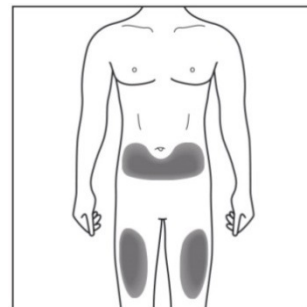

- If a **caregiver or healthcare provider** is giving your injection, they may also inject into your upper arm (see **Figure F**).

**Figure F**

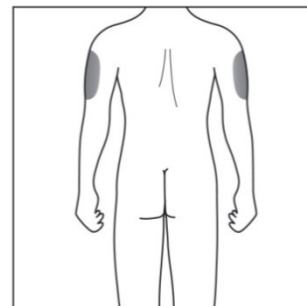

## Step 3. Cleaning your injection site:

- Wash your hands well with soap and water.
- Using a circular motion, clean the injection site with the alcohol wipe. Leave it to dry before injecting (see **Figure G**).
- Do not touch the cleaned area again before injecting.

**Figure G**

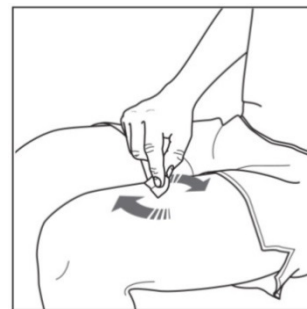

## Your injection:

### Step 4. Removing the cap:

- Only remove the cap when you are ready to use the ERELZI Sensoready Pen.
- Twist off the cap in the direction of the arrow (see **Figure H**).
- Throw away the cap. **Do not try to reattach the cap.**
- Use the ERELZI Sensoready Pen within 5 minutes of removing the cap.

**Figure H**

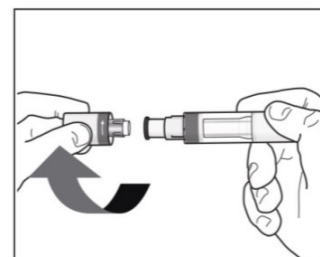

### Step 5. Holding your Sensoready Pen:

- Hold the ERELZI Sensoready Pen at a 90 degree angle to the clean injection site (see **Figure I**).

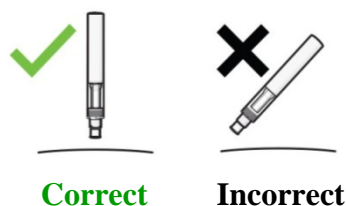

**Figure I**

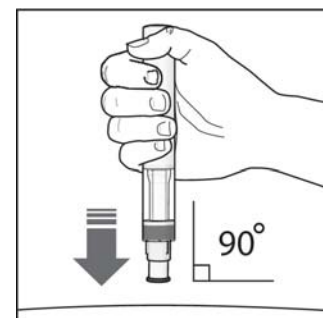

**Important: During the injection you will hear 2 loud clicks:**

- The **1<sup>st</sup> click** indicates that **the injection has started**.
- Several seconds later a **2<sup>nd</sup> click** will indicate that **the injection is almost finished**.

You must keep holding the ERELZI Sensoready Pen firmly against your skin until you see a **green indicator** fill the viewing window and stop moving.

### Step 6. Starting your injection:

- Press the ERELZI Sensoready Pen firmly against the skin to start the injection (see **Figure J**).
- The **1<sup>st</sup> click** indicates the injection has started.
- **Keep holding** the ERELZI Sensoready Pen firmly against your skin.
- The **green indicator** shows the progress of the injection.

**Figure J**

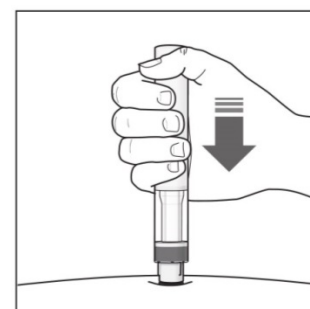

### Step 7. Completing your injection:

- Listen for the **2<sup>nd</sup> click**. This indicates the injection is **almost finished**.
- Check to make sure the **green indicator** fills the viewing window and has stopped moving (see **Figure K**).
- The ERELZI Sensoready Pen can now be removed.

**Figure K**

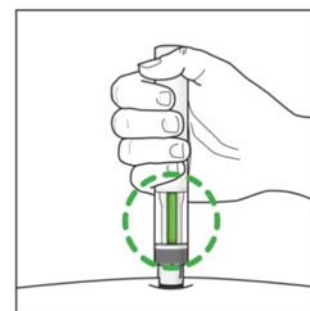

### After your injection:

#### Step 8. Check the green indicator to make sure it fills the viewing window (see **Figure L**):

- This means the medicine has been delivered. Contact your healthcare provider if the green indicator is not visible.
- There may be a small amount of blood at the injection site. You can press a cotton ball or gauze over the injection site and hold it for 10 seconds. Do not rub the injection site. You may cover the injection site with a small adhesive bandage, if needed.

**Figure L**

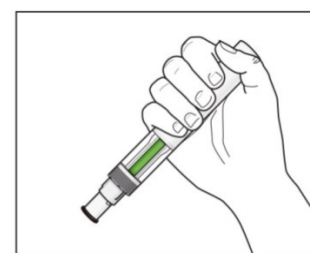

## How should I dispose of used ERELZI Sensoready Pens?

**Step 9.** Put your used ERELZI Sensoready Pens in an FDA-cleared sharps disposal container right away after use (see **Figure M**). **Do not throw away (dispose of) ERELZI Sensoready Pens in your household trash.**

If you do not have an FDA-cleared sharps disposal container, you may use a household container that is:

- made of a heavy-duty plastic,
- can be closed with a tight-fitting, puncture-resistant lid, without sharps being able to come out,
- upright and stable during use,
- leak resistant, and
- properly labeled to warn of hazardous waste inside the container.

When your sharps container is almost full, you will need to follow your community guidelines, for the right way to dispose of your sharps disposal container. There may be a state or local laws about how you should throw away used syringes, needles and ERELZI Sensoready Pens. For more information about safe sharps disposal, and for specific information about sharps disposal, in the state that you live in, go to FDA's website at: <http://www.fda.gov/safesharpsdisposal>.

Do not dispose of your used sharps disposal container in your household trash unless your community guidelines permit this. Do not recycle your used sharps disposal container.

This Instructions for Use has been approved by the U.S. Food and Drug Administration.

Manufactured by:

Sandoz Inc.

Princeton, NJ 08540

US License No. 2003

At:

Novartis Pharma AG

Stein, Switzerland

Product of Austria

Issued: August 2016

**Figure M**

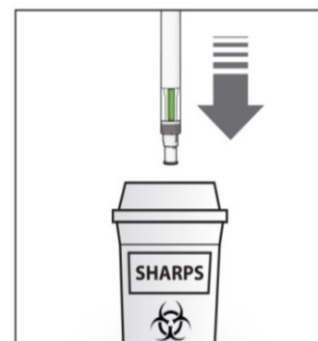



**Instructions for Use**  
**ERELZI (eh rel' zee)**  
**(etanercept-szsz)**  
**Prefilled Syringe**

**Important:**

**To help avoid a possible infection, you should follow these instructions.**

Be sure that you read, understand, and follow this Instructions for Use before injecting ERELZI. Your healthcare provider should show you how to prepare and inject ERELZI properly using the prefilled syringe before you use it for the first time. Talk to your healthcare provider if you have any questions.

**Important:**

- **Do not use** the ERELZI prefilled syringe if the seal of the blister tray is broken.
- Keep the ERELZI prefilled syringe in the original carton to protect from light or damage until you are ready to use it.
- Inject ERELZI 15 to 30 minutes after taking it out of the refrigerator.
- **Do not shake** the ERELZI prefilled syringe.
- **The needle cap on the prefilled syringe contains latex. Do not handle the prefilled syringe if you are sensitive to latex.**
- The prefilled syringe has a needle guard that will be activated to cover the needle after the injection is given. The needle guard will help to prevent needle stick injuries to anyone who handles the prefilled syringe.
- Do not remove the needle cap until just before you give the injection.
- Avoid touching the needle guard wings before use. Touching them may cause the needle guard to be activated too early.
- Throw away (dispose of) the used ERELZI prefilled syringe right away after use. **Do not re-use a ERELZI prefilled syringe.** See “**How should I dispose of used ERELZI prefilled syringes?**” at the end of this Instructions for Use.

**How should I store ERELZI?**

- Store your carton of ERELZI prefilled syringes in the refrigerator, between 36°F to 46°F (2°C to 8°C).
- If needed, you may store the ERELZI prefilled syringe at room temperature between 68°F to 77°F (20°C to 25°C) for up to 28 days. Once the ERELZI prefilled syringe has reached room temperature, do not put it back into the refrigerator. Throw away the ERELZI prefilled syringe that has been stored at room temperature after 28 days.
- Keep ERELZI prefilled syringes in the original carton until ready to use to protect from light.
- Do not store ERELZI in extreme heat or cold such as in your vehicle’s glove box or trunk.
- Do not freeze ERELZI prefilled syringes.

Keep ERELZI and all medicines out of the reach of children.

ERELZI prefilled syringe parts (see Figure A).

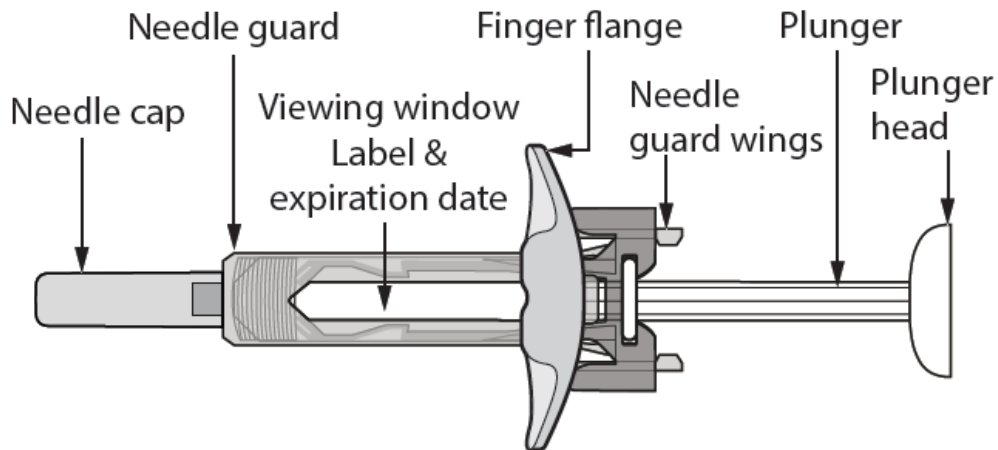

**Figure A** ERELZI prefilled syringe with needle guard and finger flange

- In this configuration the Needle Guard is Activated- Do not use the pre-filled syringe (see Figure B)

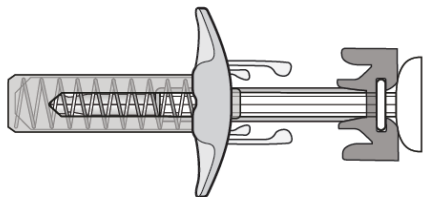

**Figure B** Device Activated – Do Not Use

- In this configuration the Needle Guard is not activated and the prefilled syringe is ready for use (see Figure C)

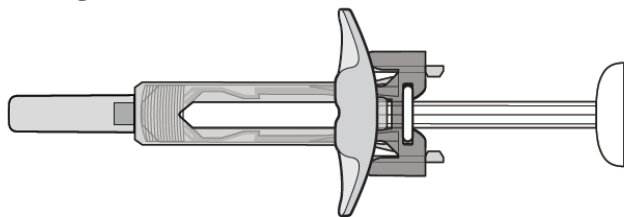

**Figure C** Device Ready to Be Used

### What you need for your injection:

Included in the carton:

A new ERELZI prefilled syringe (see Figure C)

Each prefilled syringe contains 25 mg/0.5 mL or 50 mg/mL of ERELZI.

Not included in the carton (see **Figure D**):

- 1 Alcohol wipe
- 1 Cotton ball or gauze
- Sharps disposal container
- 1 Adhesive bandage

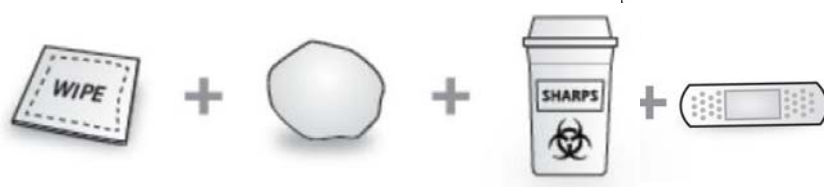

See “**How should I dispose of used ERELZI prefilled syringes?**” at the end of this Instructions for Use.

### Step 1: Preparing the ERELZI Prefilled Syringe

1. Find a clean, well-lit, flat work surface, such as a table.
2. Take the blister containing the ERELZI prefilled syringe out of the refrigerator and leave it **unopened** on your work surface for about 15 to 30 minutes to allow it to reach room temperature. **Do not** try to warm the ERELZI prefilled syringe by using a heat source such as hot water or a microwave.
3. Wash your hands well with soap and water.
4. Take the ERELZI prefilled syringe out of the blister.
5. Look through the viewing window. The liquid should be clear and colorless to slightly yellow. It is normal to see small white particles in the liquid. **Do not use** if the liquid is cloudy, discolored, or has large lumps, flakes, or particles in it. Return the prefilled syringe and the package it came in to your pharmacy.
6. **Do not** use the ERELZI prefilled syringe if it is broken or the needle guard is activated. Return the prefilled syringe and the package it came in to your pharmacy.
7. **Do not** use the ERELZI prefilled syringe if the expiration date has passed. Return the prefilled syringe and the package it came in to your pharmacy.

### Step 2: Choosing and Preparing an Injection Site

1. The recommended site is the front of your thighs. You may also use the lower abdomen, but **not** the area 2 inches (5 cm) around your navel (belly button) (see **Figure E**).
2. Choose a different site each time you give yourself an injection.
3. **Do not** inject into areas where the skin is tender, bruised, red or hard. Avoid areas with scars or stretch marks.
4. If you have psoriasis, **do not** inject directly into any raised, thick, red, or scaly skin.
5. If a **caregiver** or **healthcare provider** is giving you your injection, they may also inject into your outer upper arm (see **Figure F**).
6. Using a circular motion, clean the injection site with the alcohol wipe. Leave it to dry before injecting. Do not touch the cleaned area again before injecting.

**Figure E**

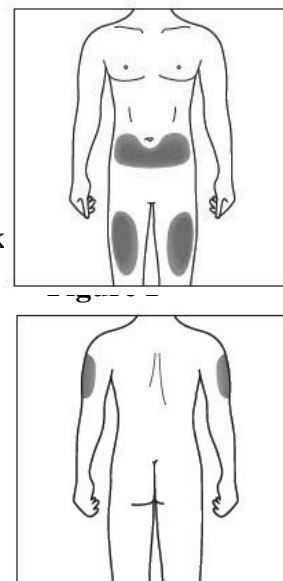

### Step 3: Injecting ERELZI Using a Prefilled Syringe

**Only remove the needle cap when you are ready to use the ERELZI prefilled syringe.**

1. Carefully remove the needle cap from the ERELZI prefilled syringe (see **Figure G**). Throw away the needle cap. You may see a drop of liquid at the end of the needle. This is normal.

**Figure G**

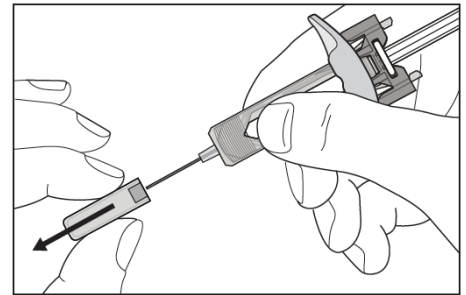

2. With one hand gently pinch the skin at the injection site. With your other hand insert the needle into your skin as shown (see **Figure H**). Push the needle all the way in to make sure that you inject your full dose.

**Figure H**

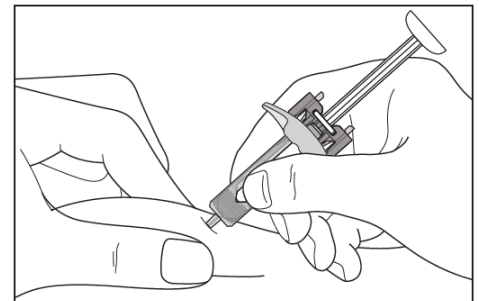

3. Hold the ERELZI prefilled syringe as shown (see **Figure I**). Slowly press down on the plunger as far as it will go, so that the plunger head is completely between the needle guard wings.

**Figure I**

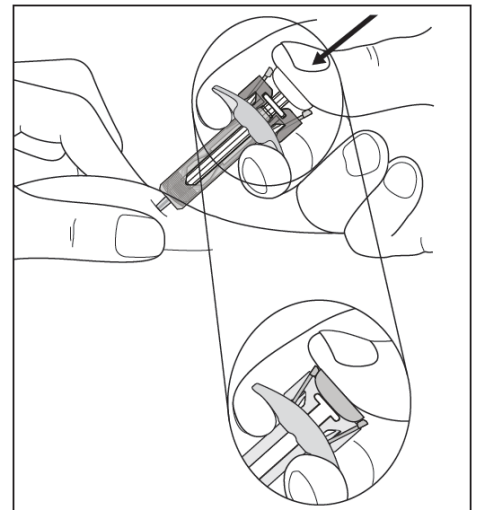

4. Keep the plunger fully pressed down while you hold the syringe in place for 5 seconds.

5. Keep the plunger fully pressed down while you carefully pull the needle straight out from the injection site (see **Figure J**).

**Figure J**

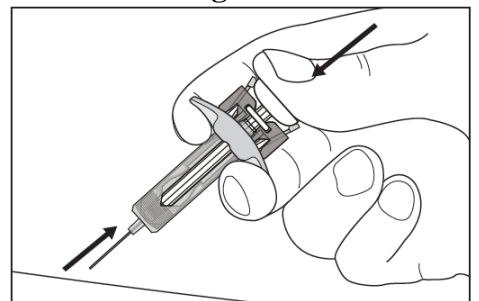

6. Slowly release the plunger and allow the needle guard to automatically cover the exposed needle (**see Figure K**).
7. There may be a small amount of blood at the injection site. You can press a cotton ball or gauze over the injection site and hold it for 10 seconds. Do not rub the injection site. You may cover the injection site with a small adhesive bandage, if needed.

**Figure K**

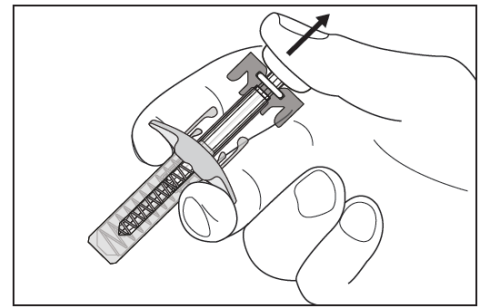

### **How should I throw away used ERELZI prefilled syringes?**

Put your used prefilled syringes in an FDA-cleared sharps disposal container right away after use (**see Figure L**). **Do not throw away (dispose of) ERELZI prefilled syringes in your household trash.**

If you do not have an FDA-cleared sharps disposal container, you may use a household container that is:

- made of a heavy-duty plastic,
- can be closed with a tight-fitting, puncture-resistant lid, without sharps being able to come out,
- upright and stable during use,
- leak-resistant, and
- properly labeled to warn of hazardous waste inside the container.

When your sharps disposal container is almost full, you will need to follow your community guidelines for the right way to dispose of your sharps disposal container. There may be state or local laws about how you should throw away used needles, syringes, and prefilled syringes. For more information about safe sharps disposal, and for specific information about sharps disposal in the state that you live in, go to the FDA's website at: <http://www.fda.gov/safesharpsdisposal>

Do not dispose of your used sharps disposal container in your household trash unless your community guidelines permit this. Do not recycle your used sharps disposal container.

**Figure L**

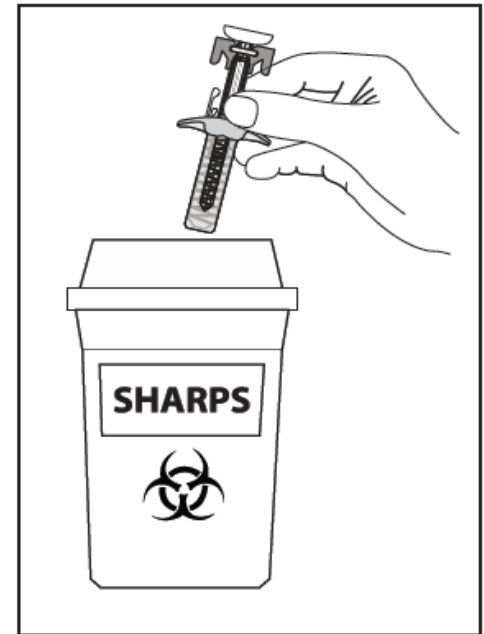

This Instructions for Use has been approved by the U.S. Food and Drug Administration.

Manufactured by:

Sandoz Inc.

Princeton, NJ 08540

US License No. 2003

At:

Novartis Pharma AG

Stein, Switzerland

Product of Austria

Issued: 08 2016